



STAR WARS



9516



1

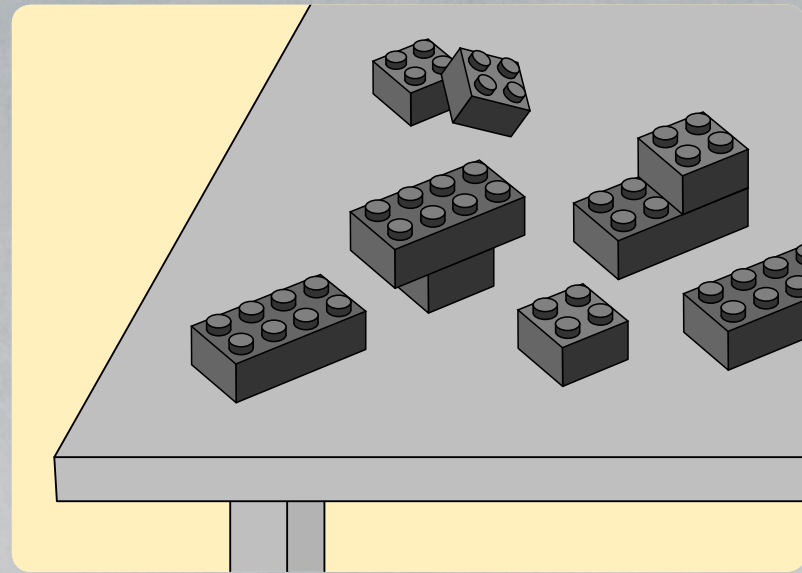
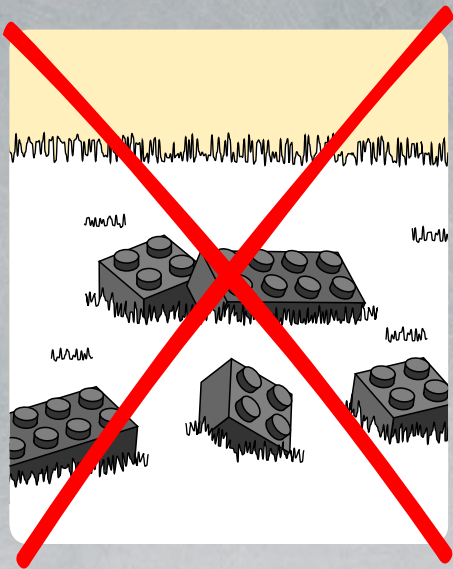

2

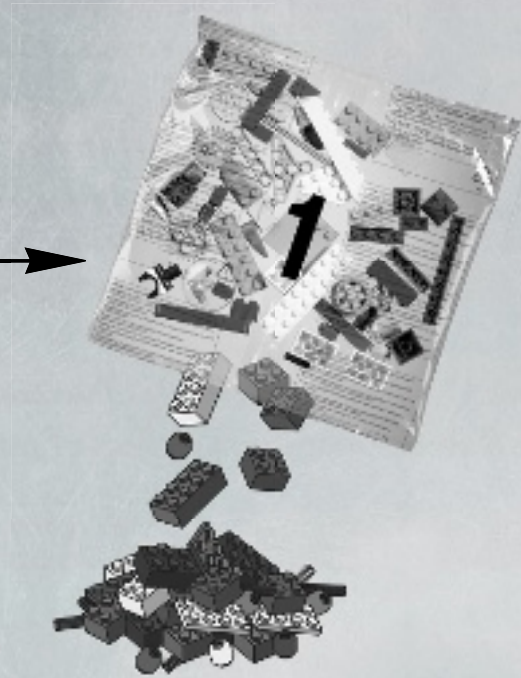

<http://lego.com/brickseparator>

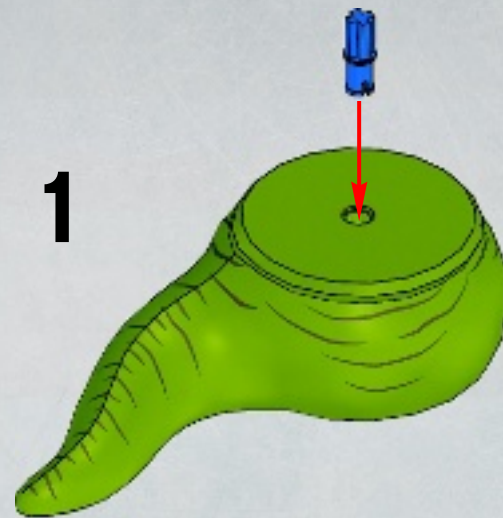
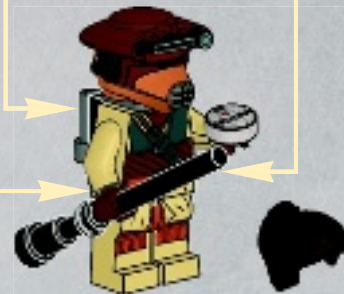
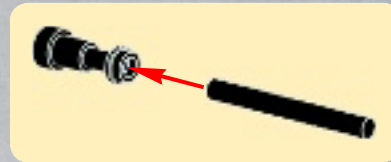
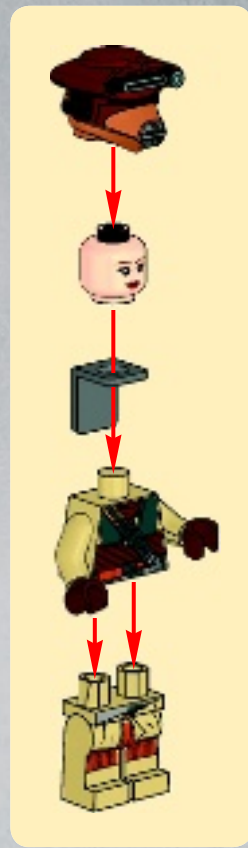



1



2



3

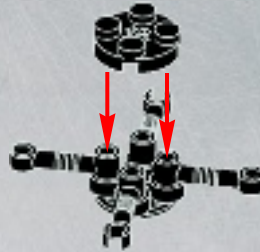

4

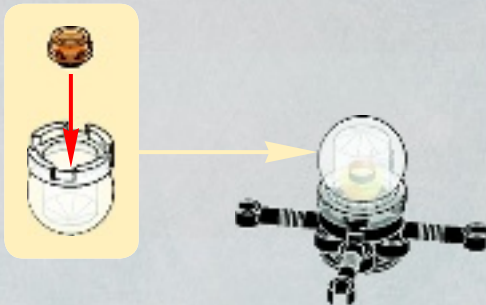

5



6



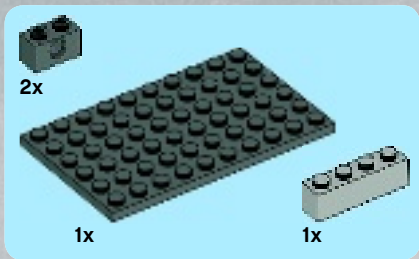
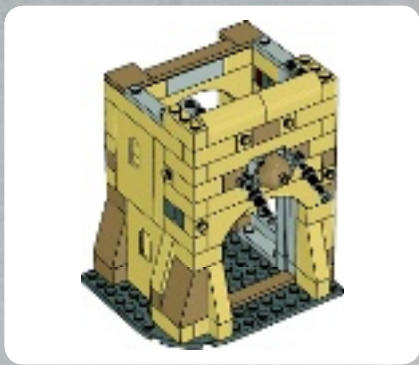

1

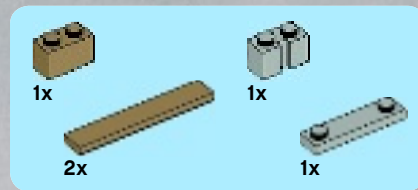
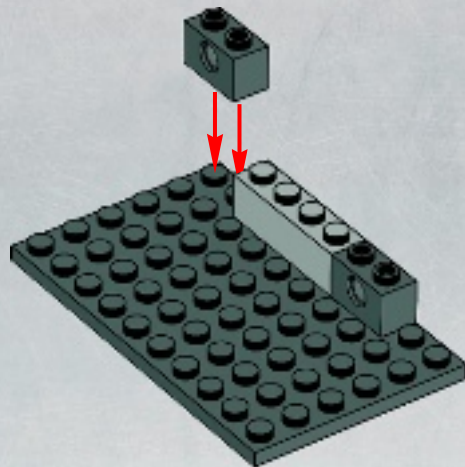

2

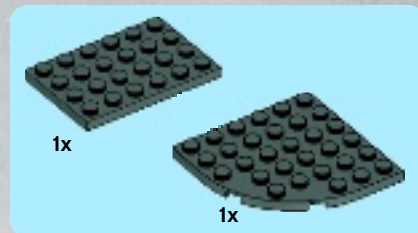
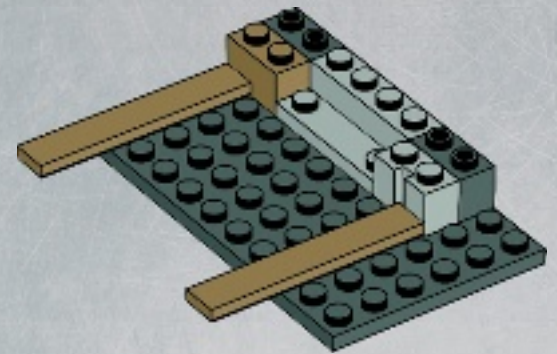

3

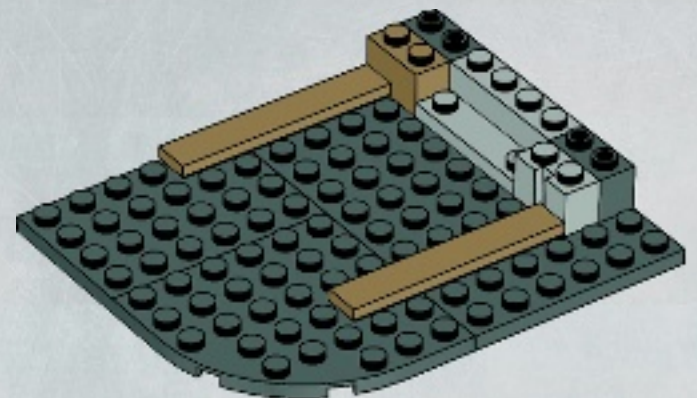

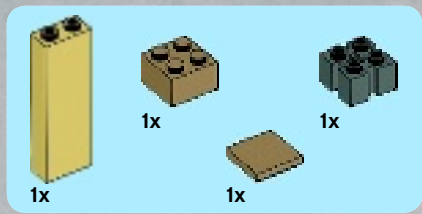

4

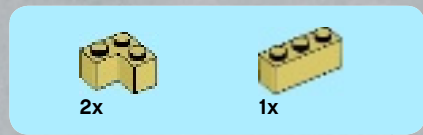
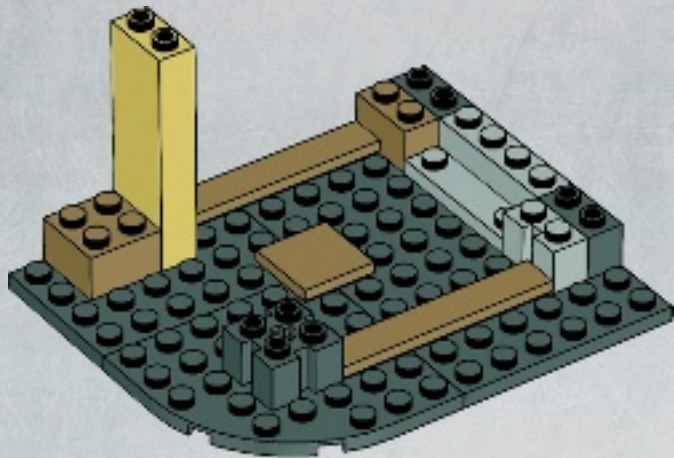

5

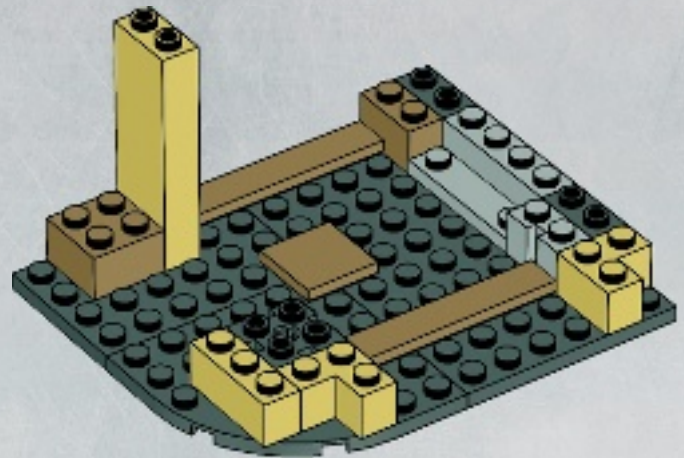



6

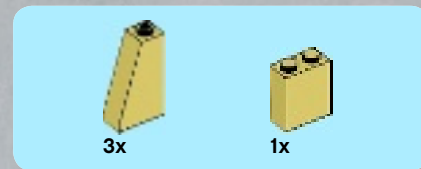
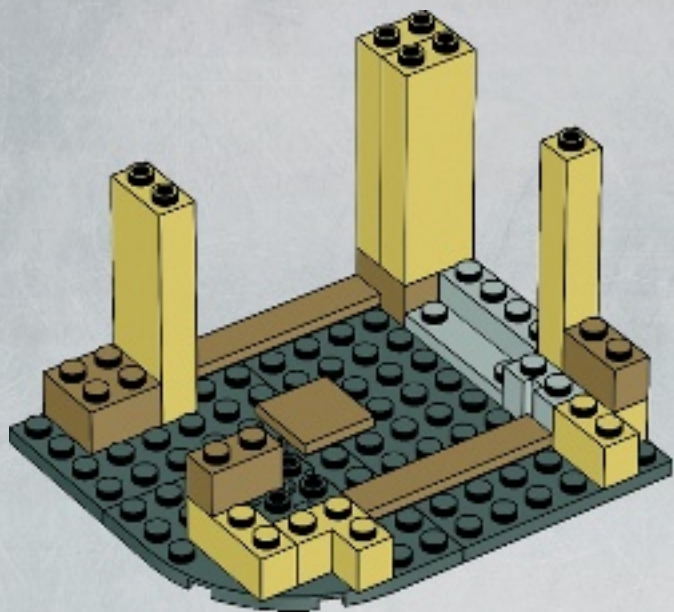

7

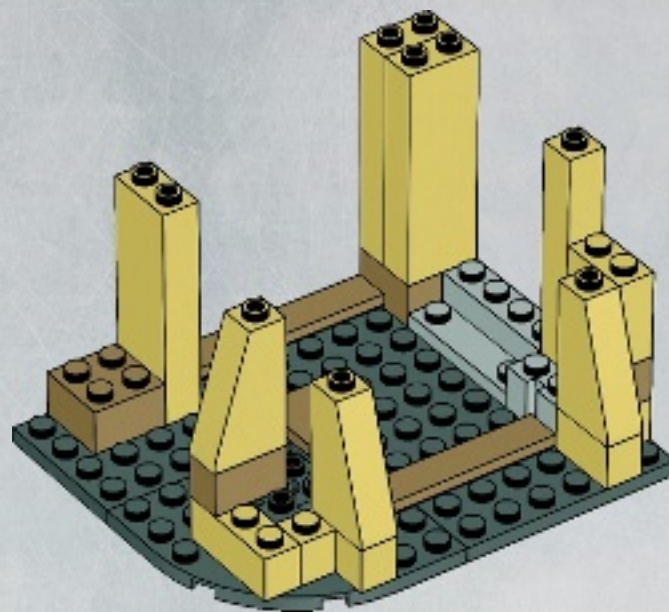



8

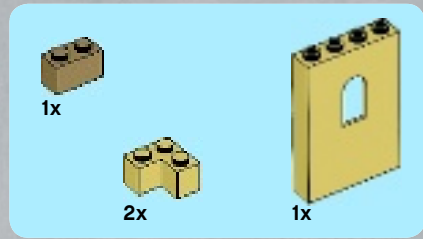
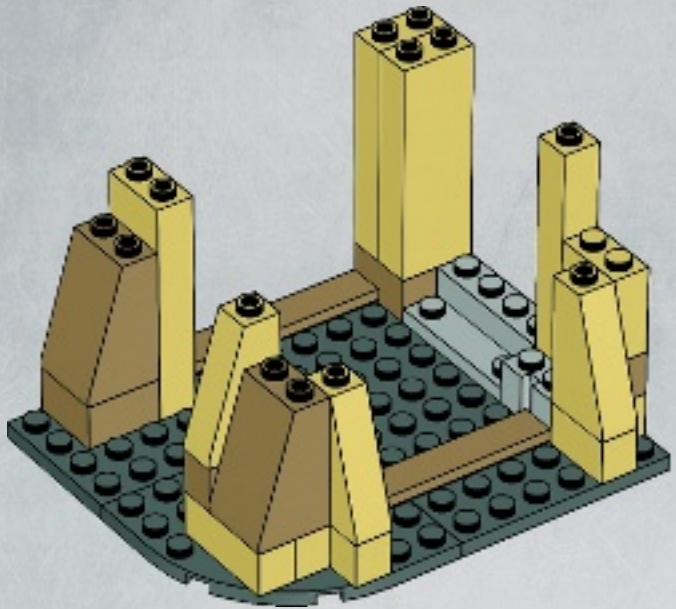

9

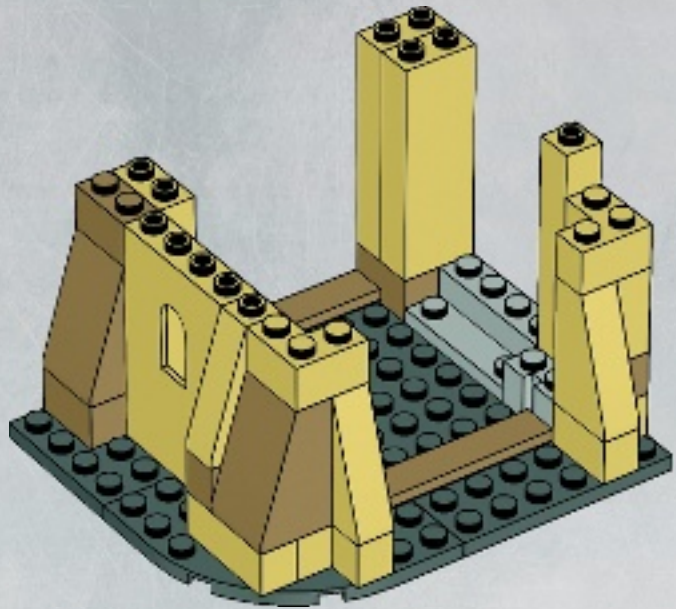

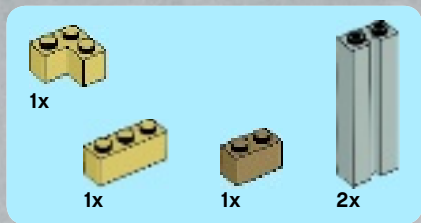

10

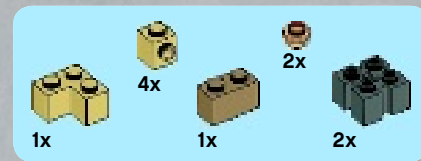
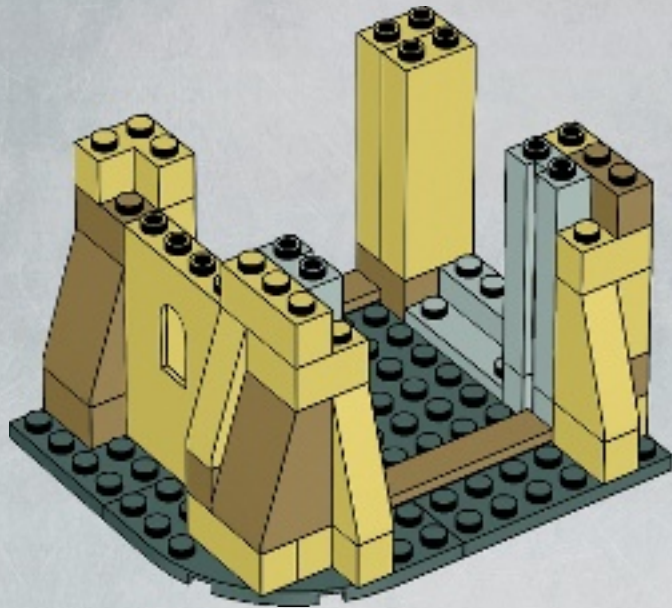

11

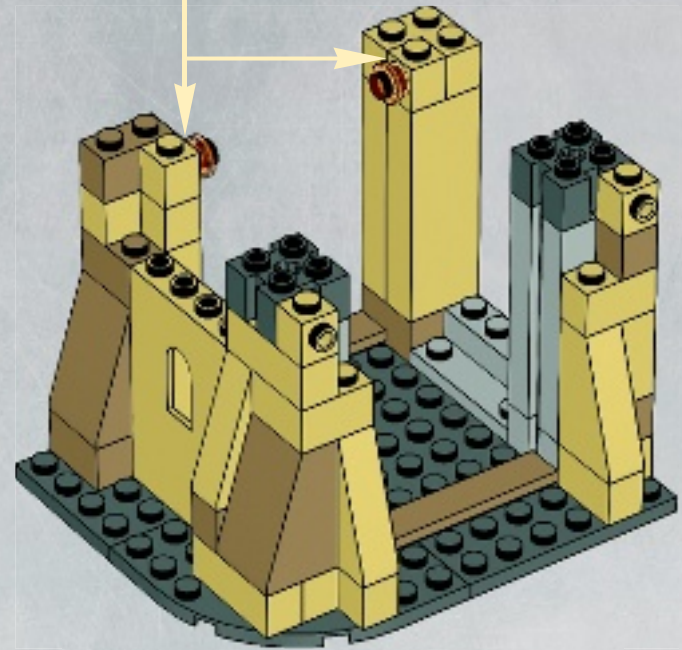
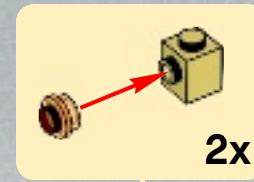

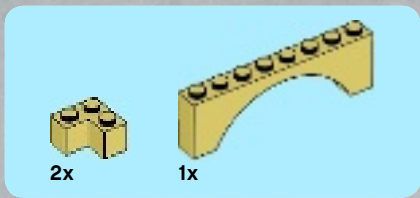

12

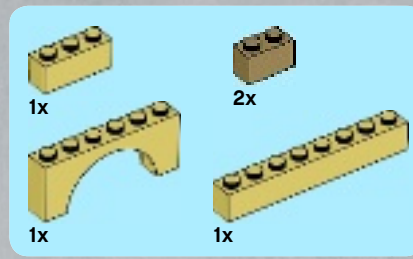
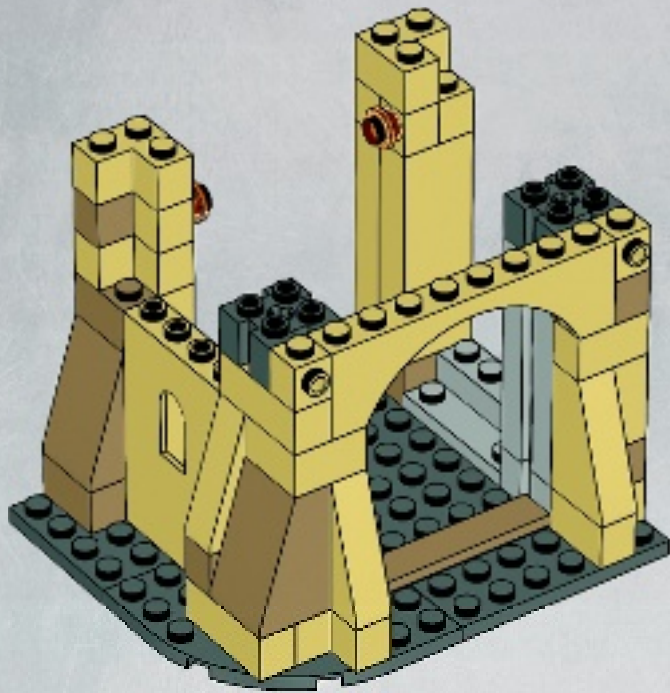

13

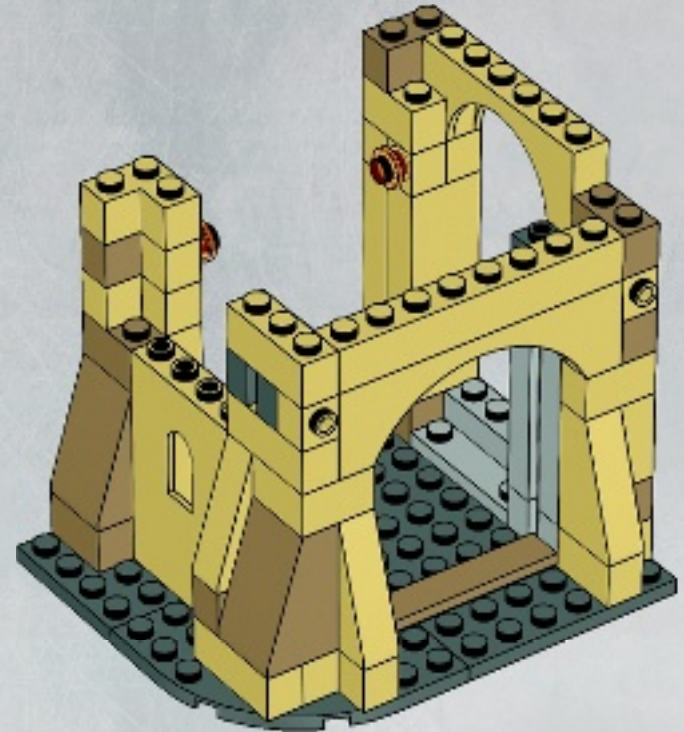



14

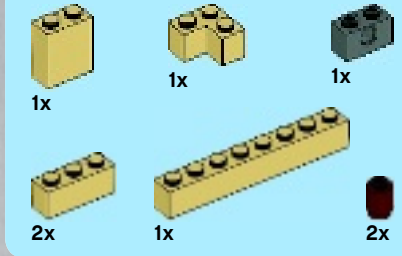
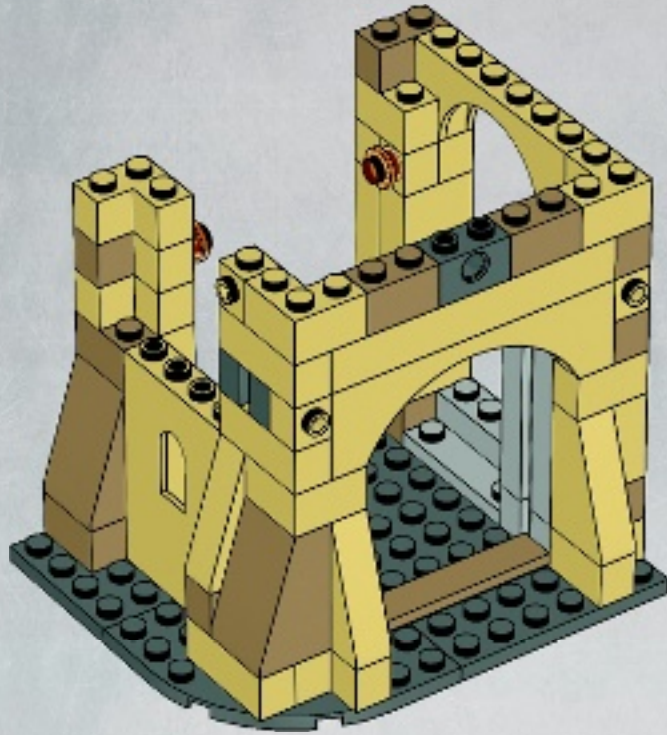

15

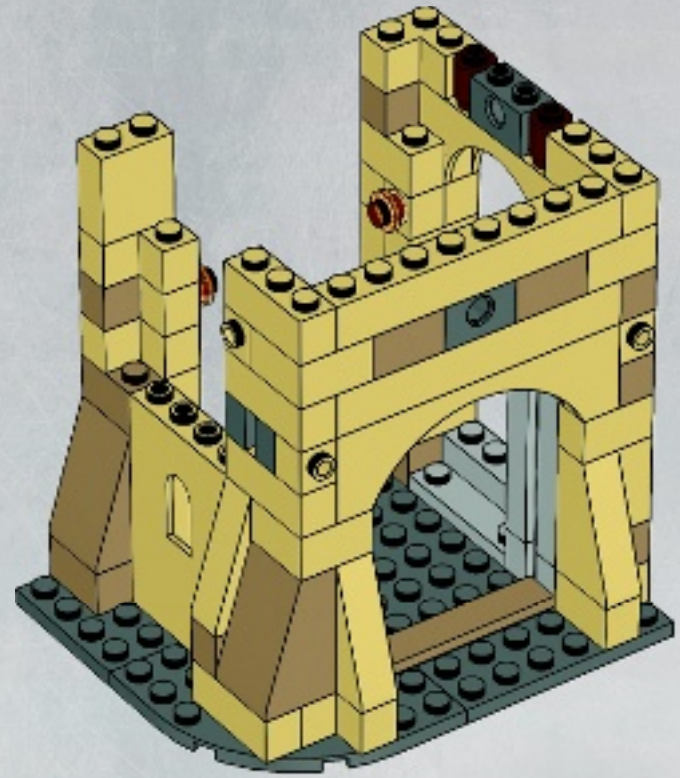

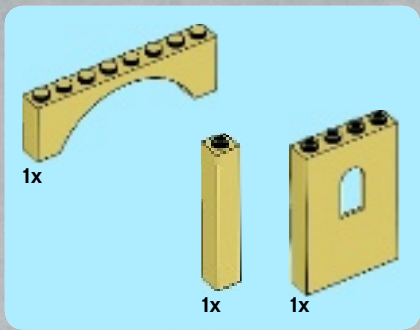

16

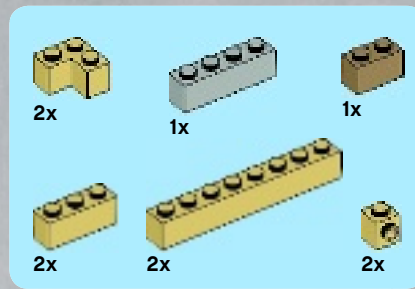
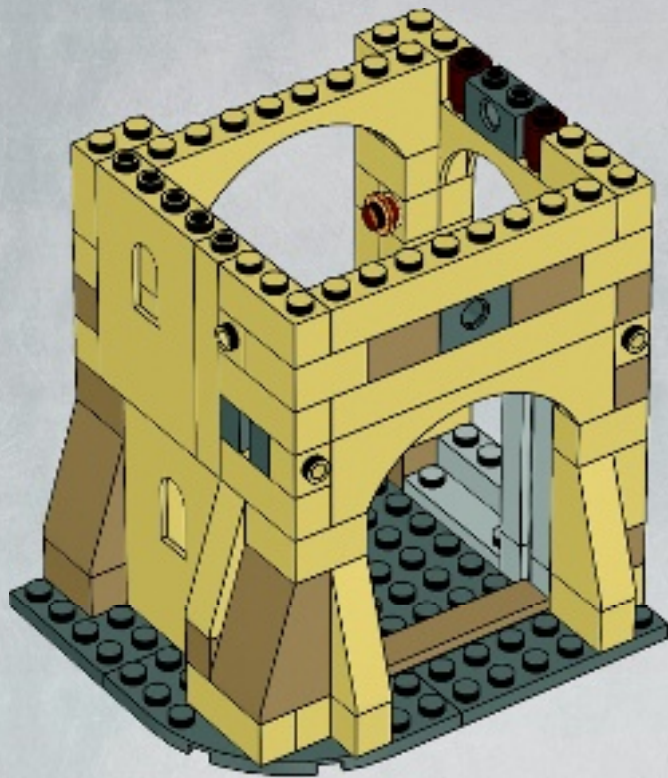

17

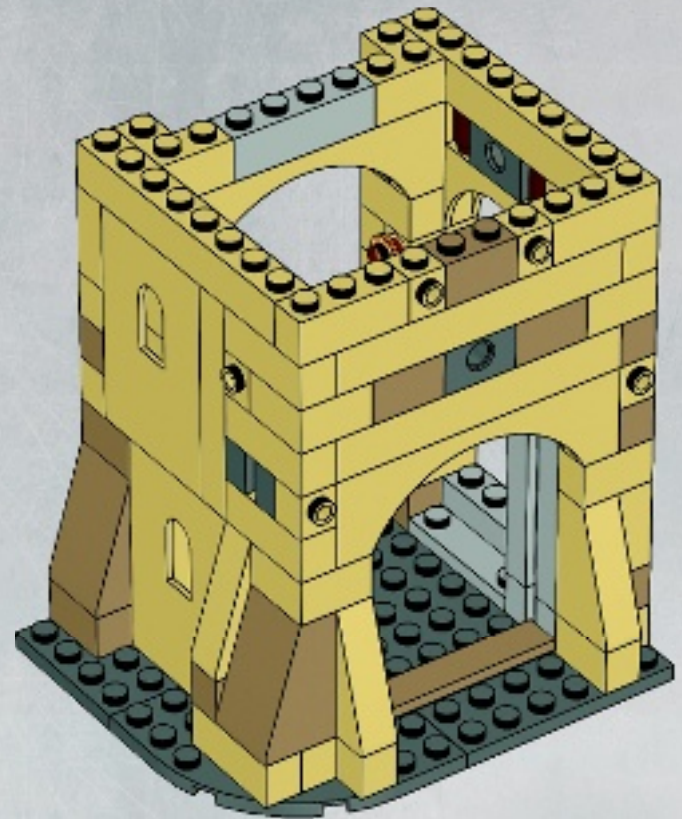

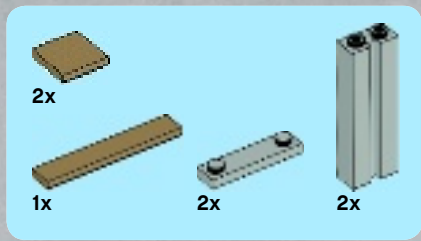

18

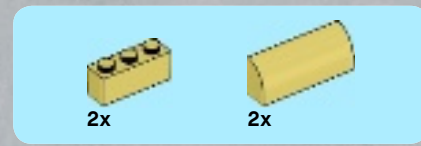
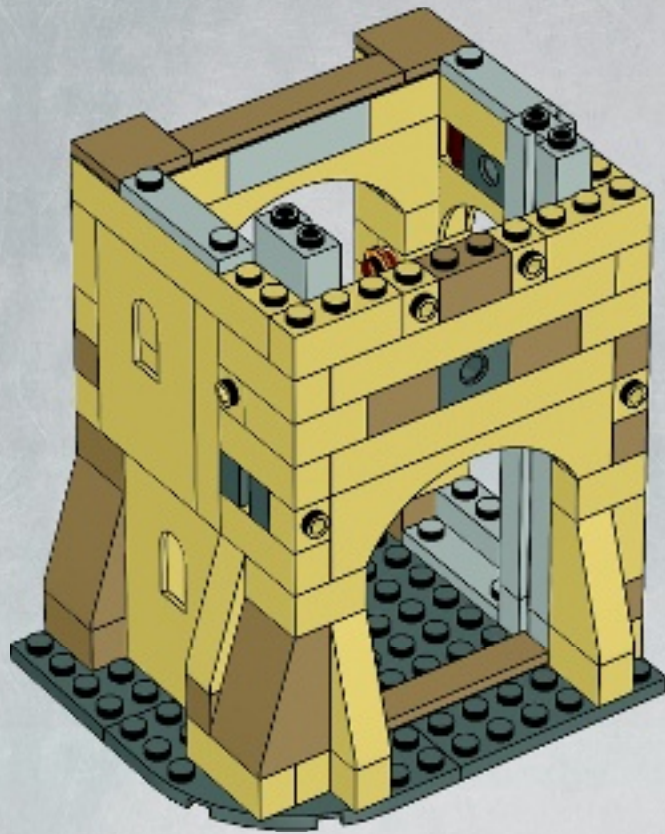

19

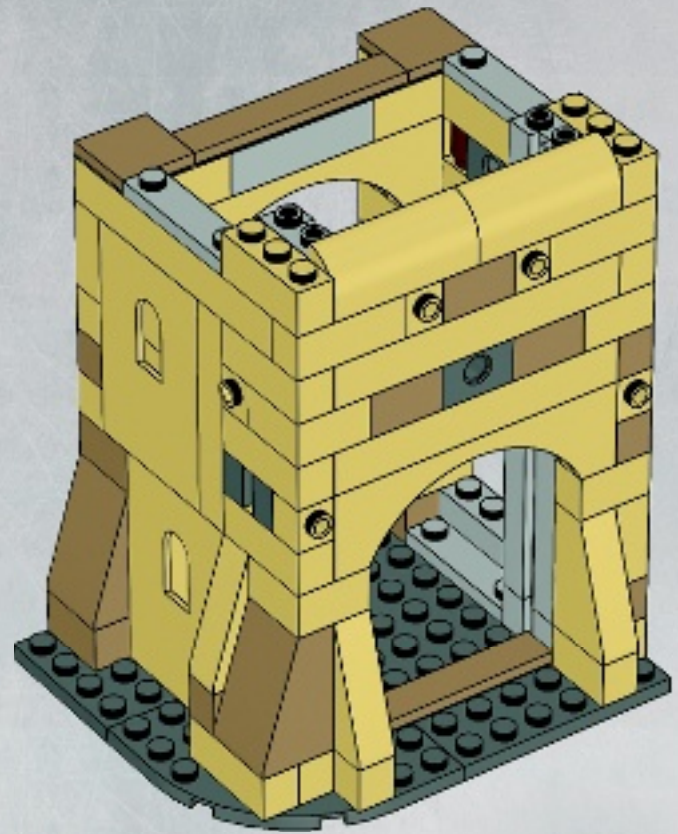



20

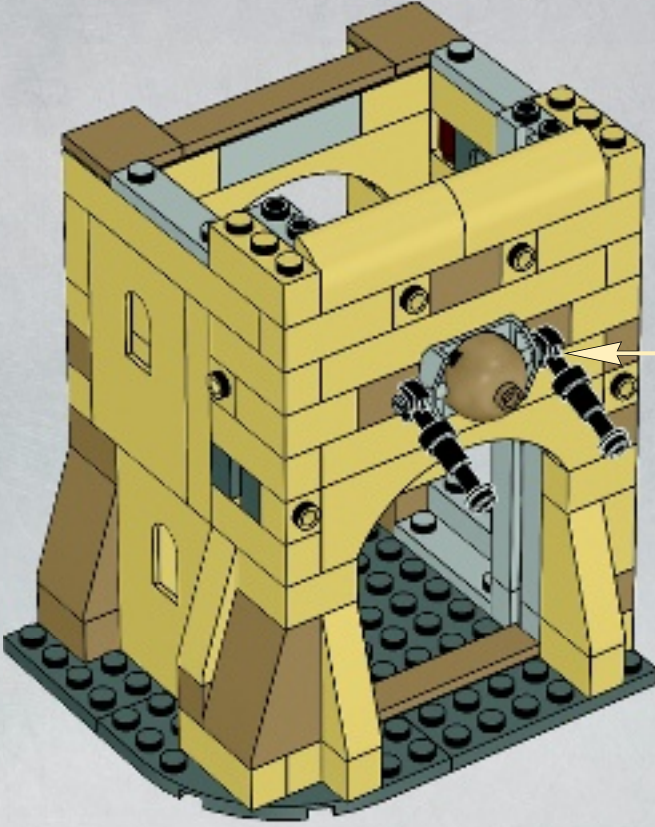

1

2

3

4

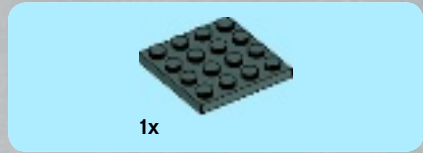
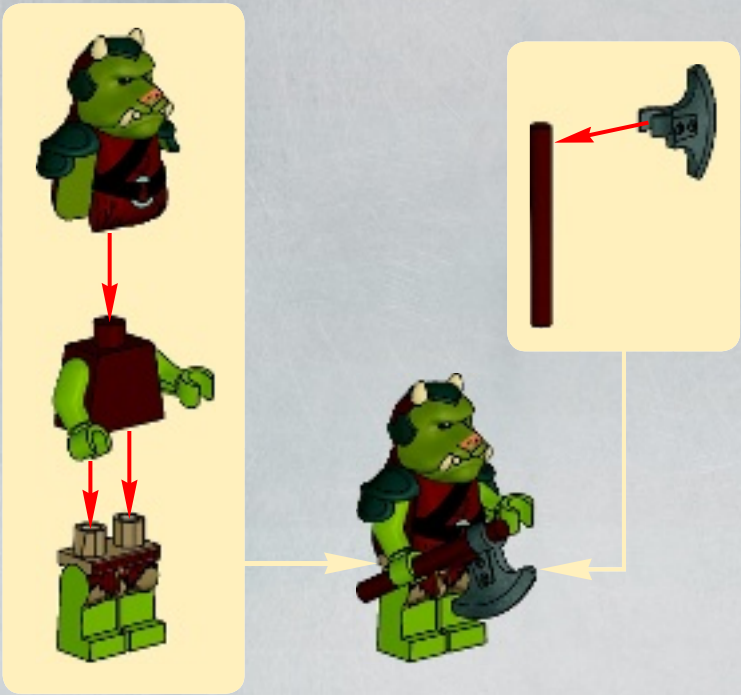

1

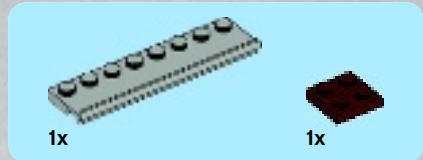

2

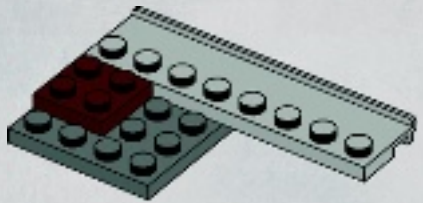



1x

3

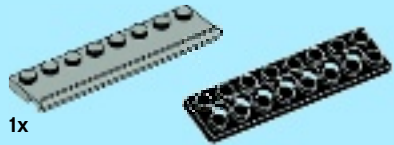
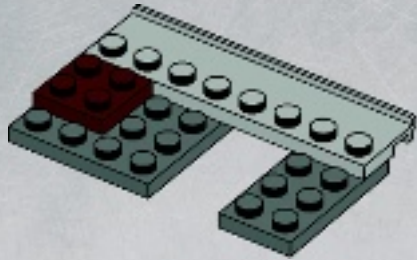

1x

1x

4

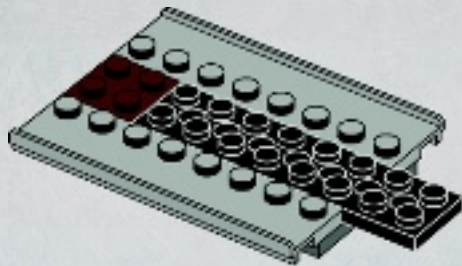

1x

2x

1x

1x

5

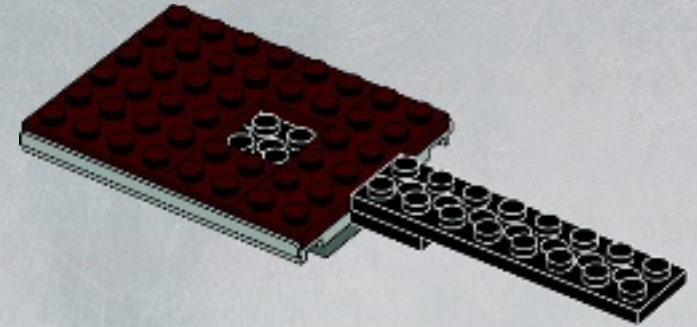

2x



1x



13x

6

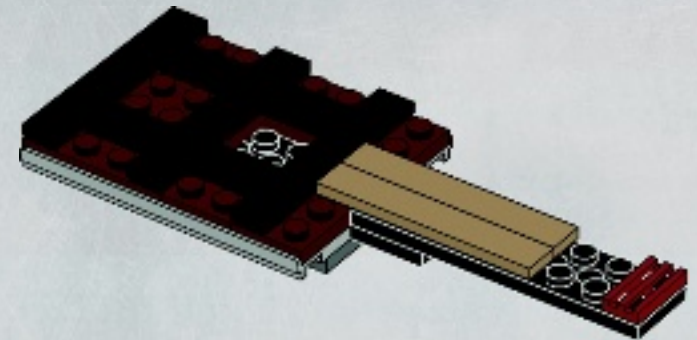



7

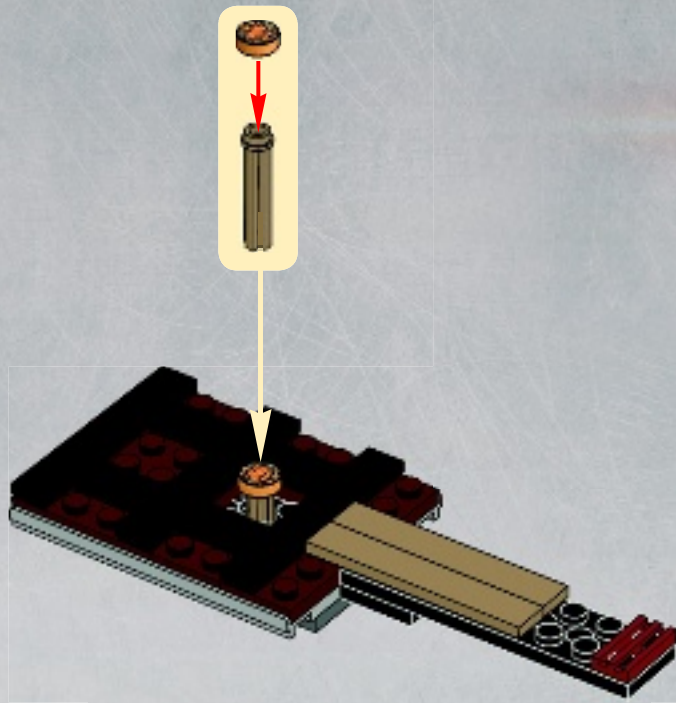

8



9

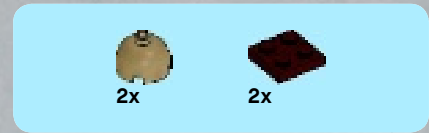
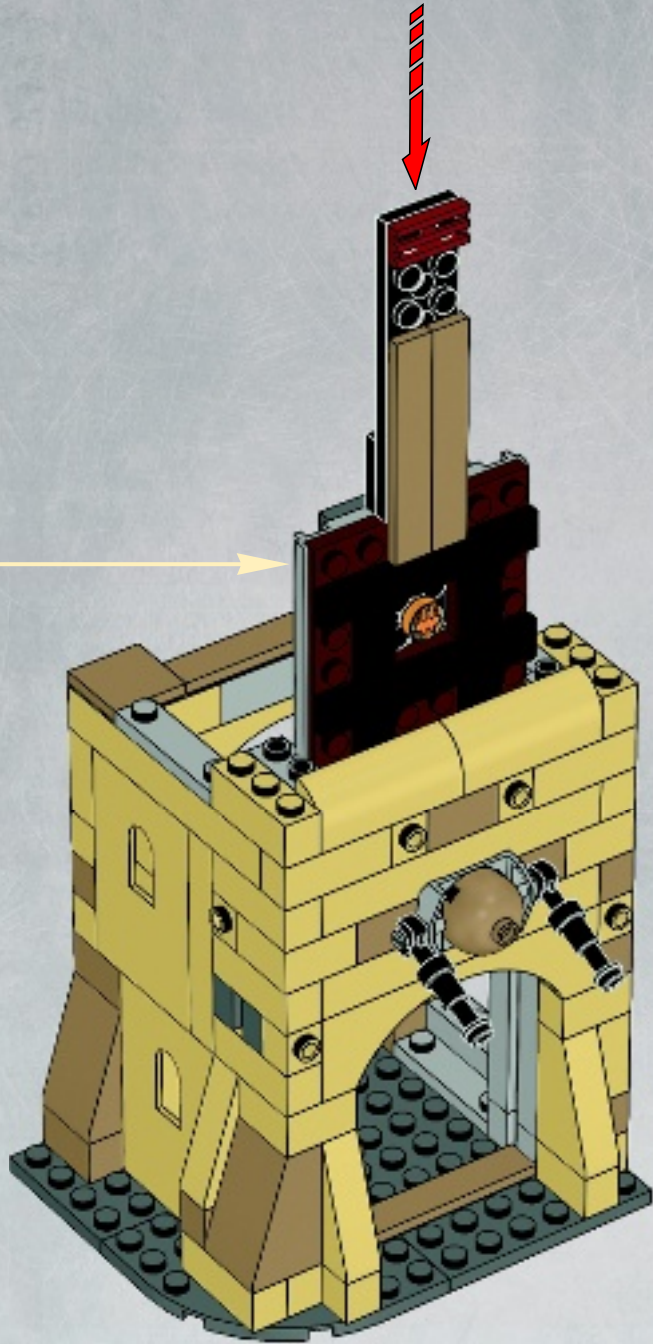

10

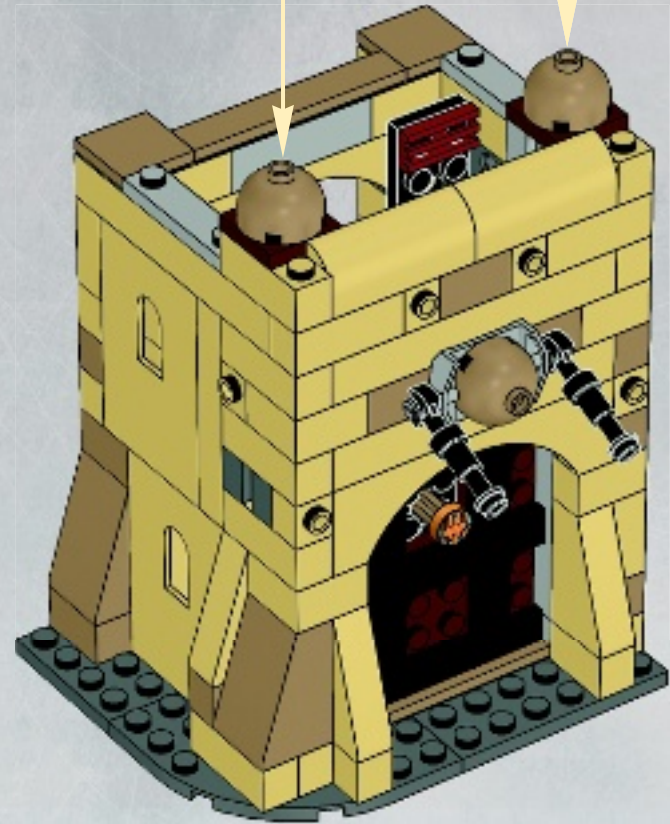

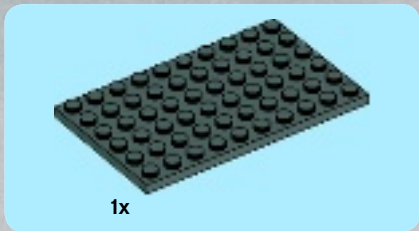
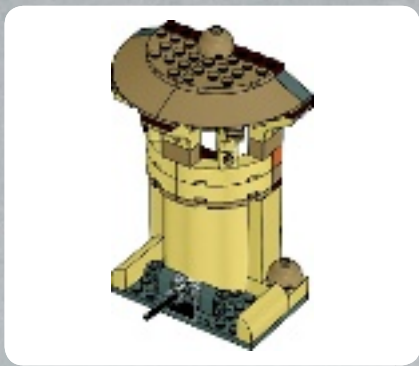

1x

1

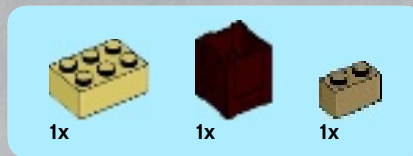

1x

1x

1x

2

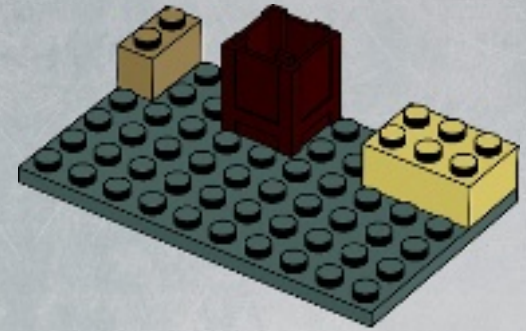

2x

1x

3

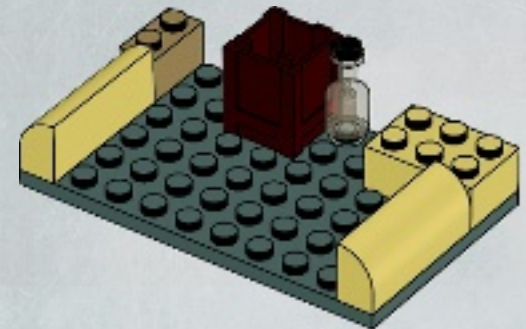

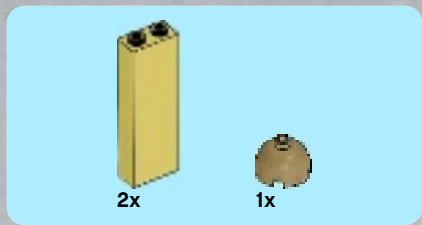

4

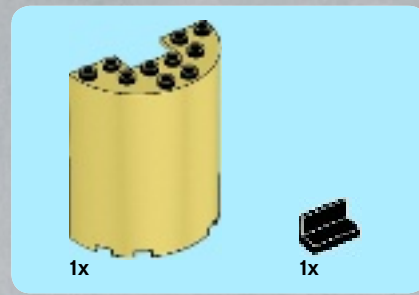
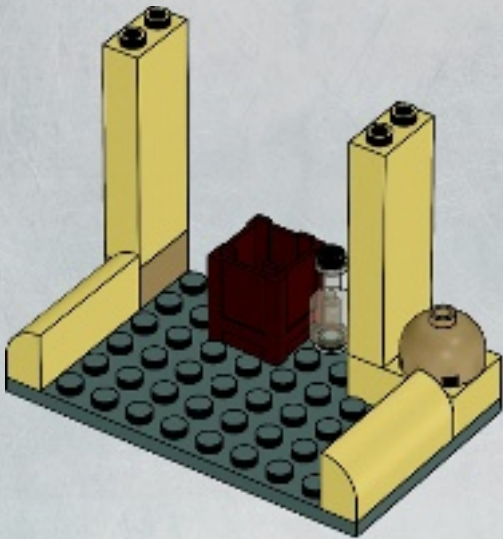

5

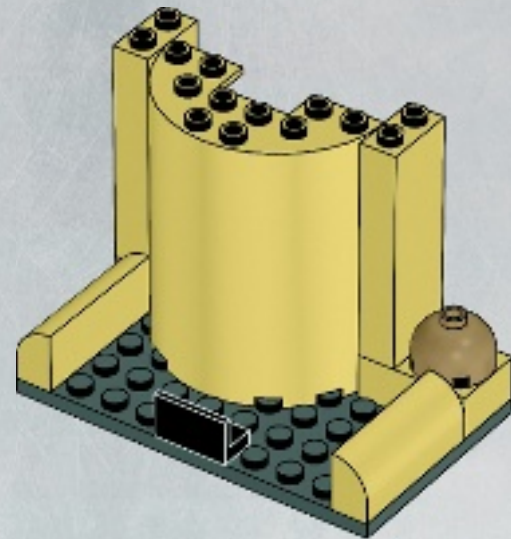



6

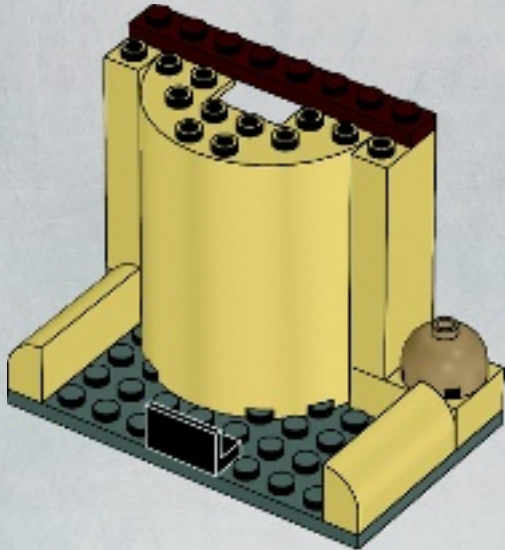

7

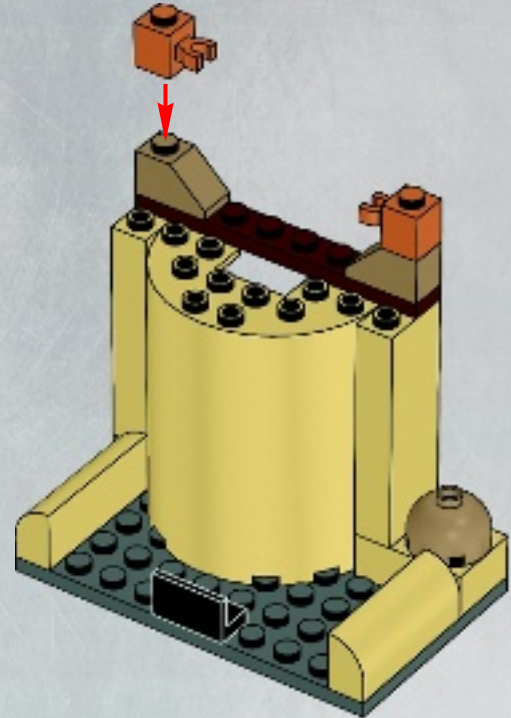



8

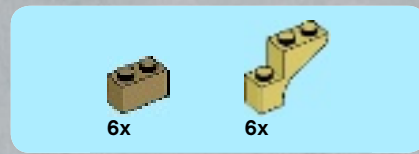
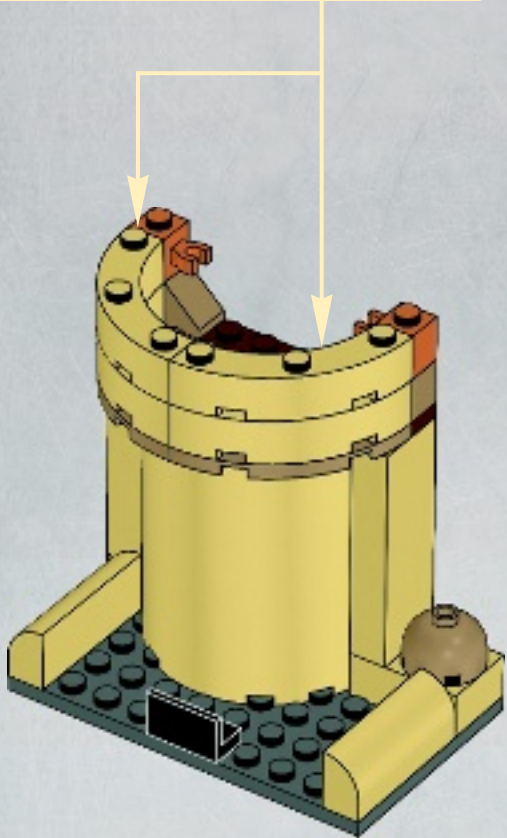
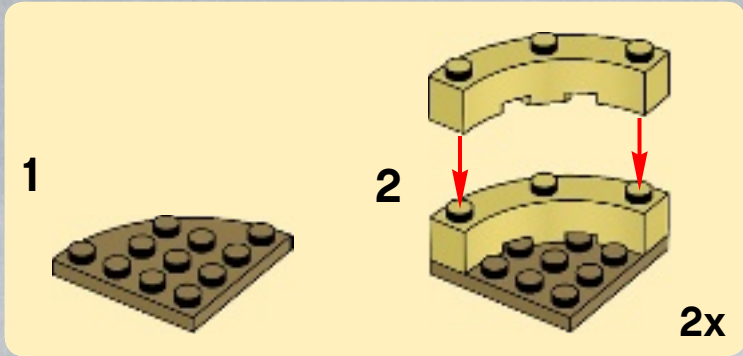

9

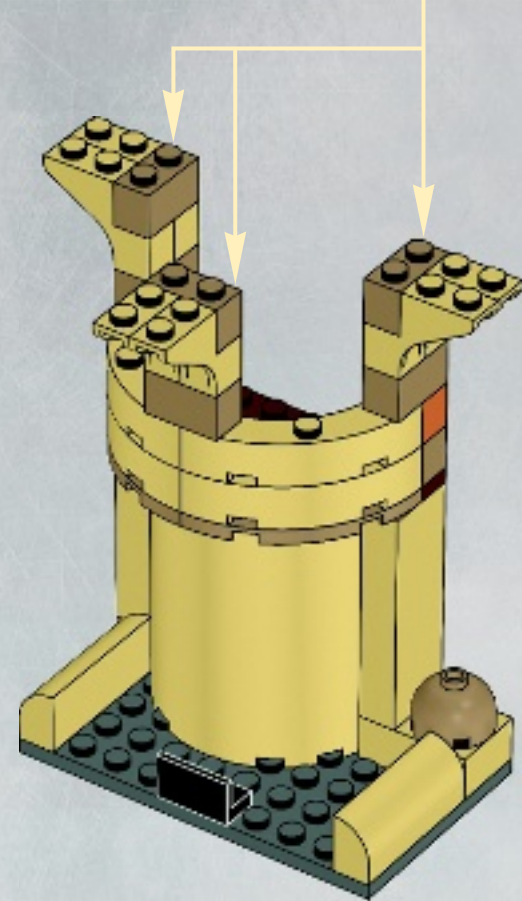
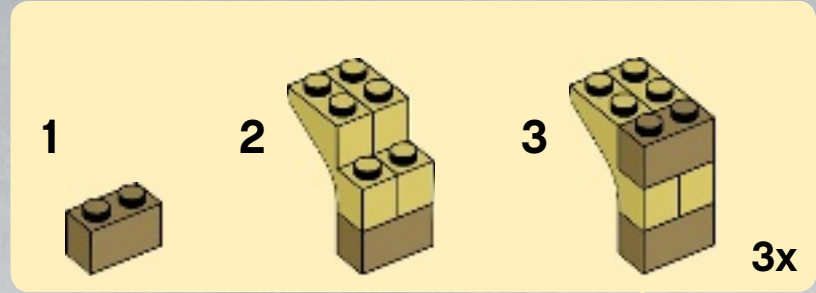

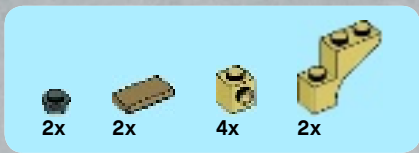

10

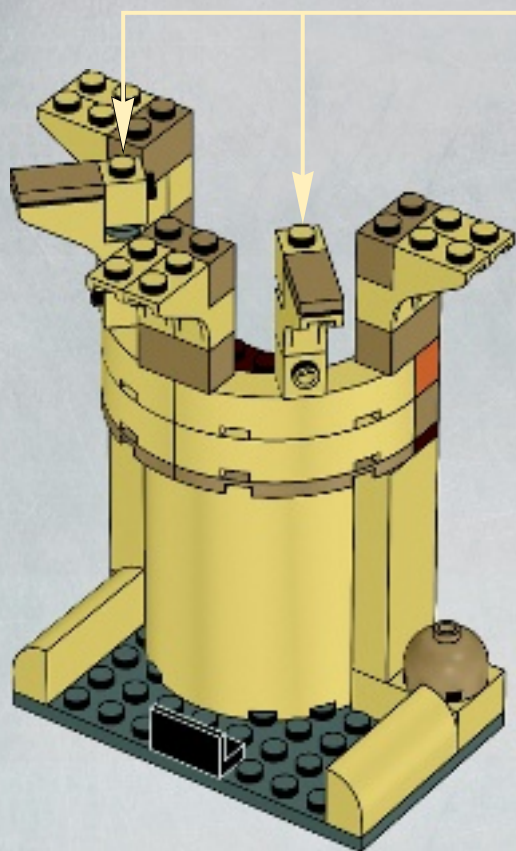
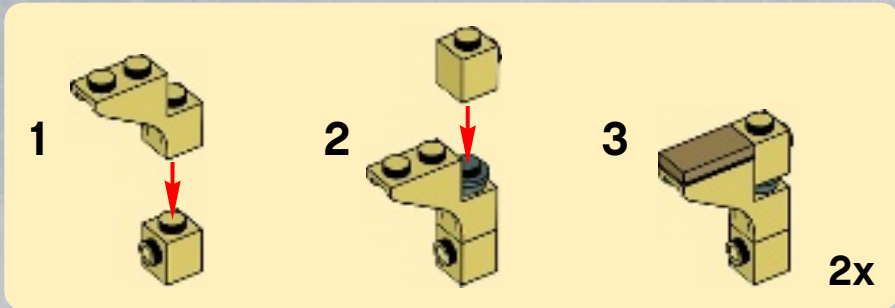

11

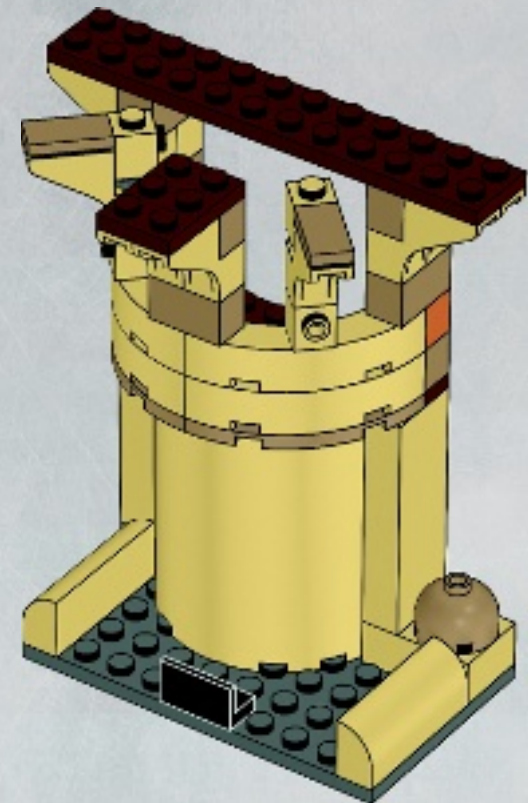



12

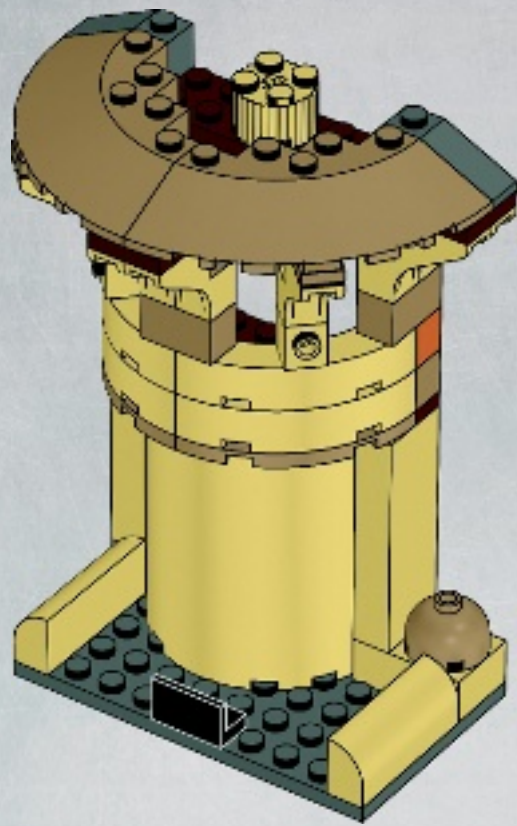

13

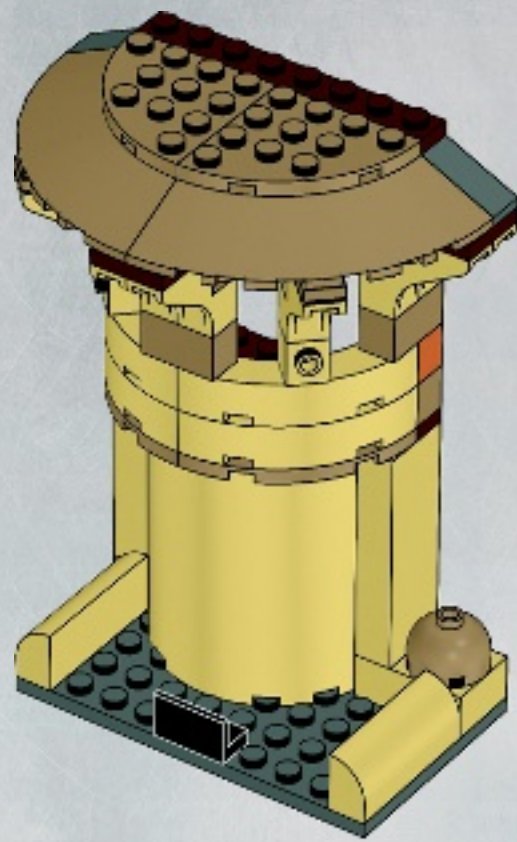

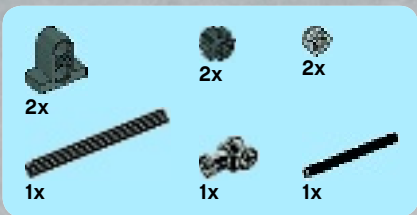

14

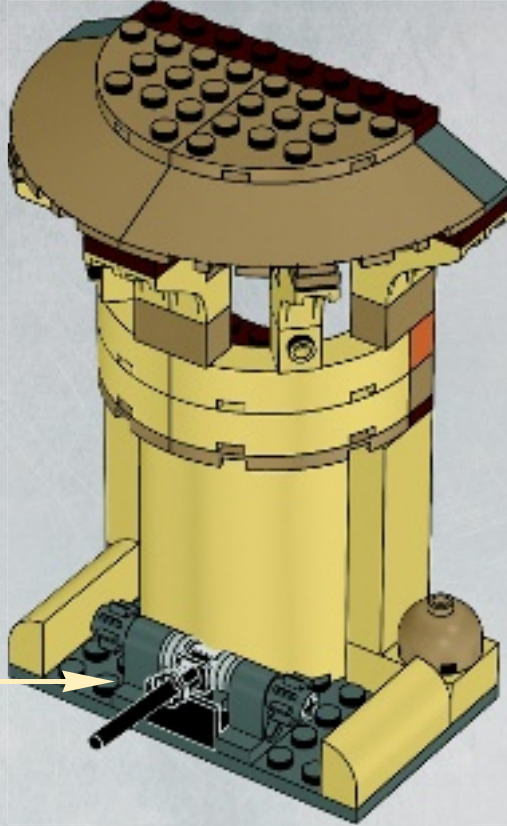
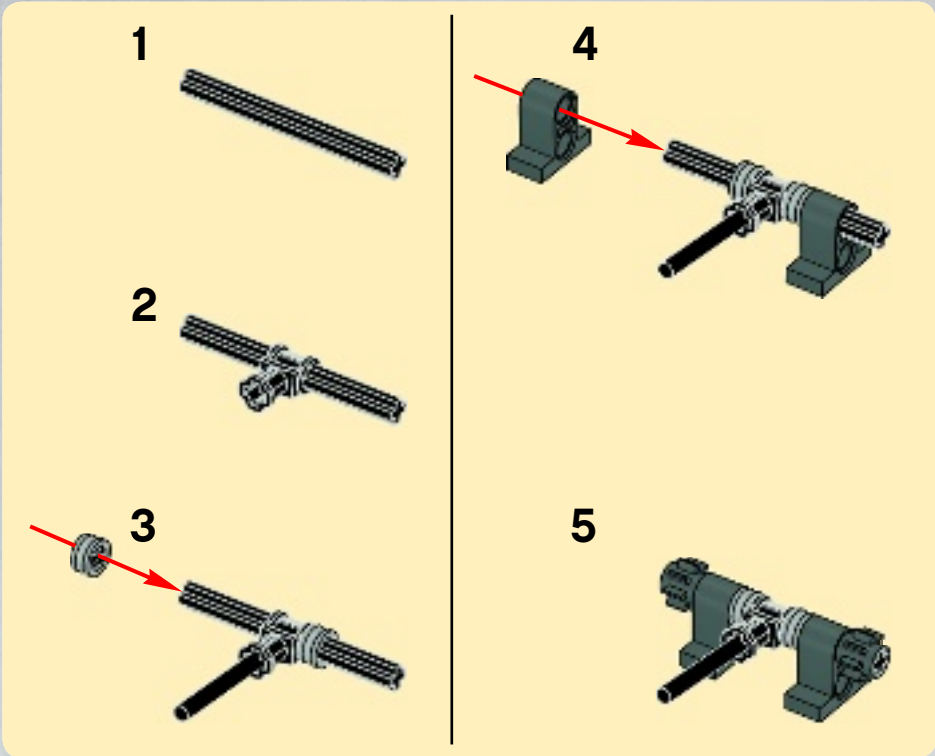



1x



1x



1x



1x

15

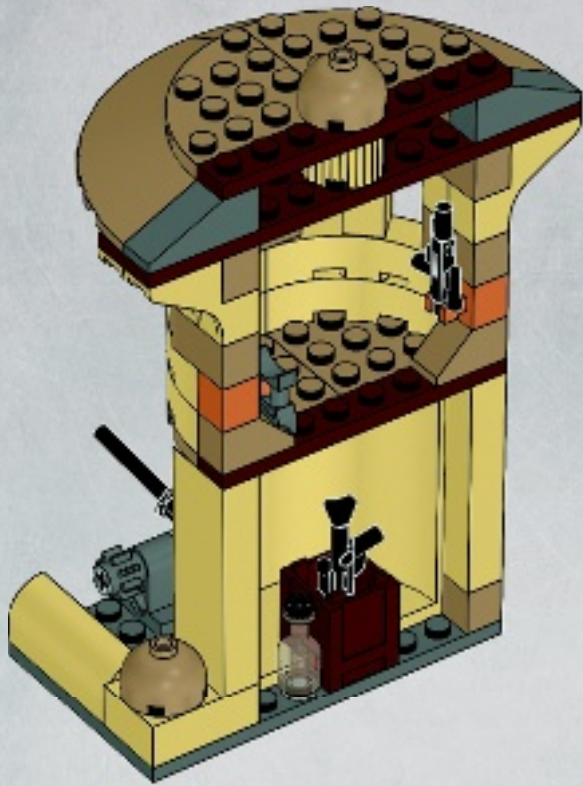

16

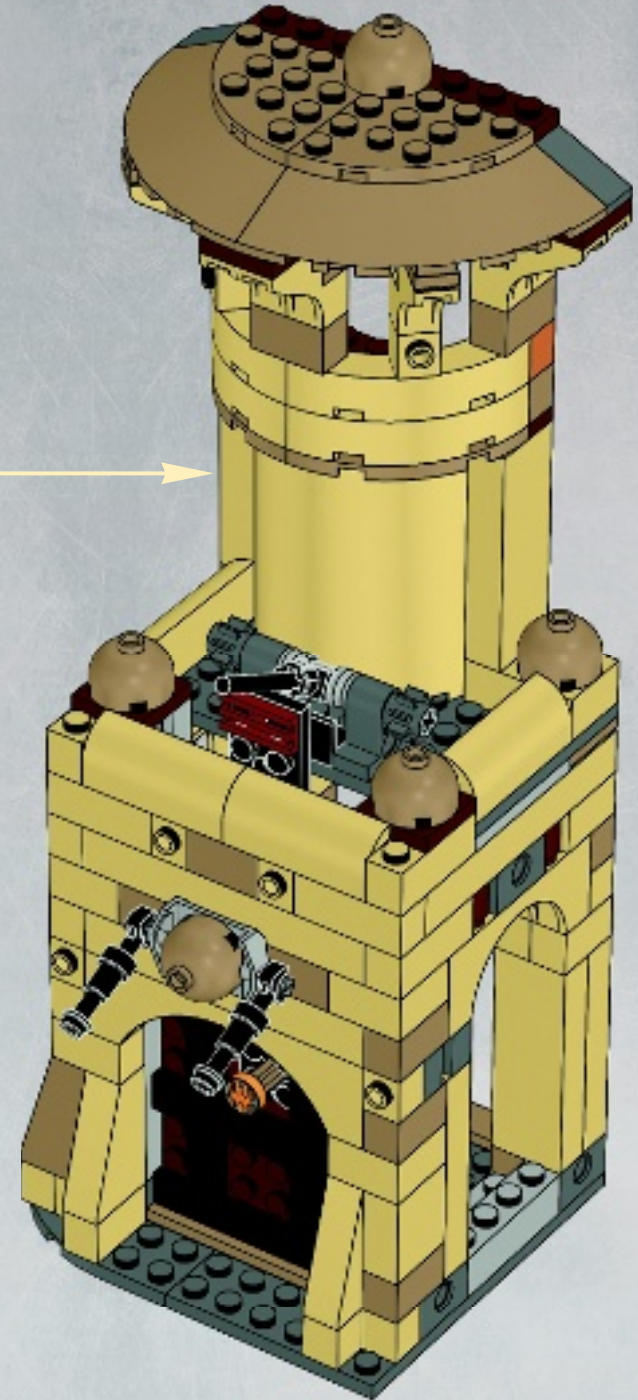

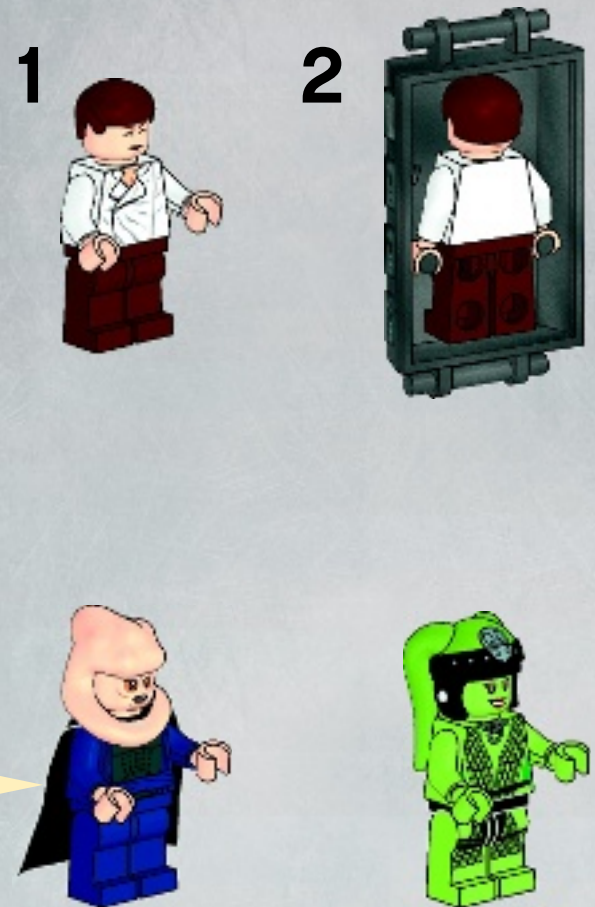
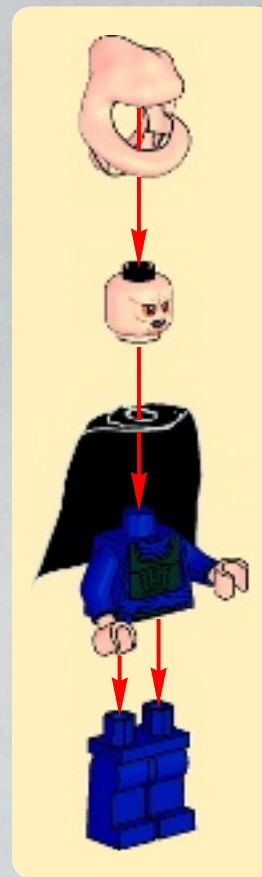
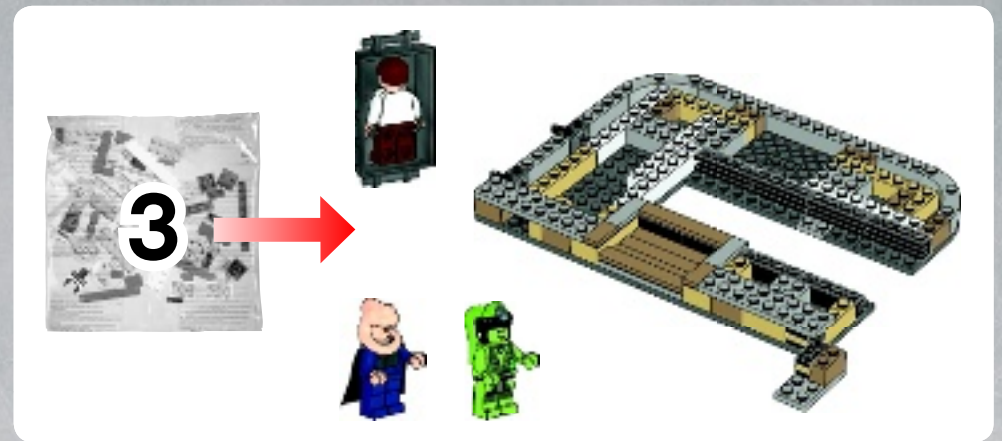
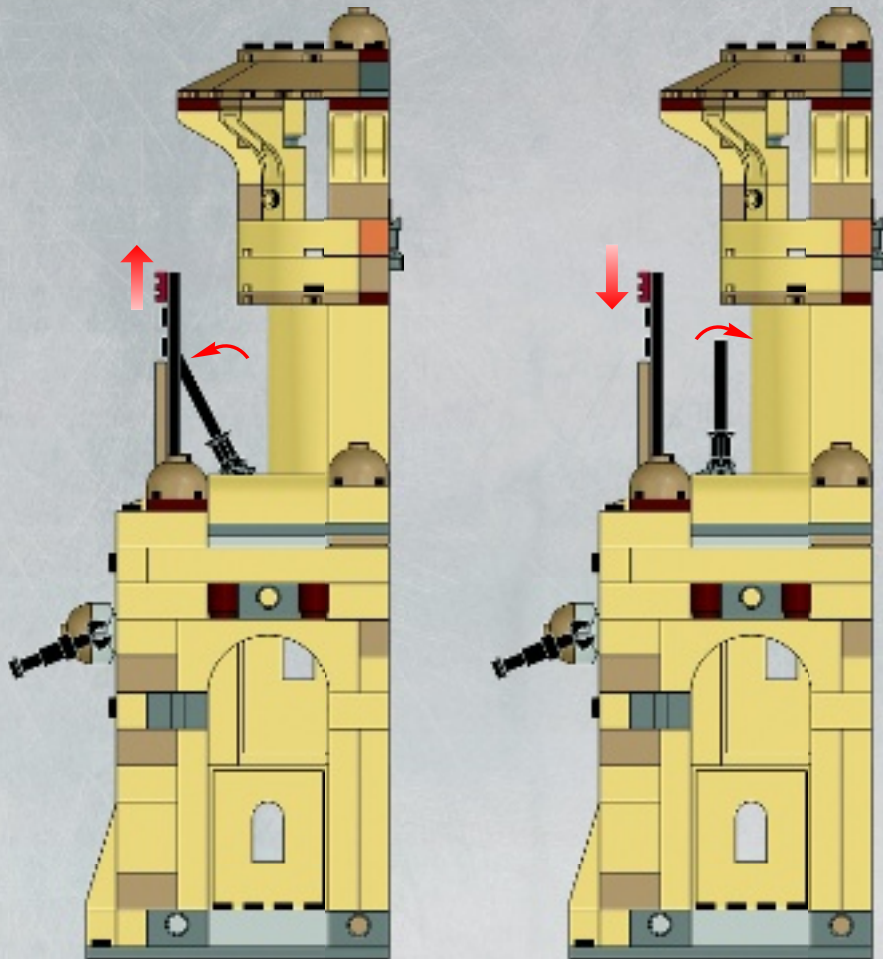

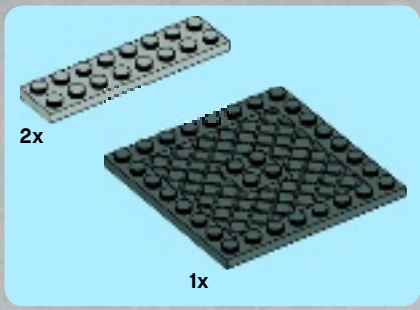

1

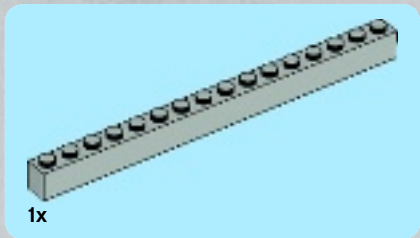
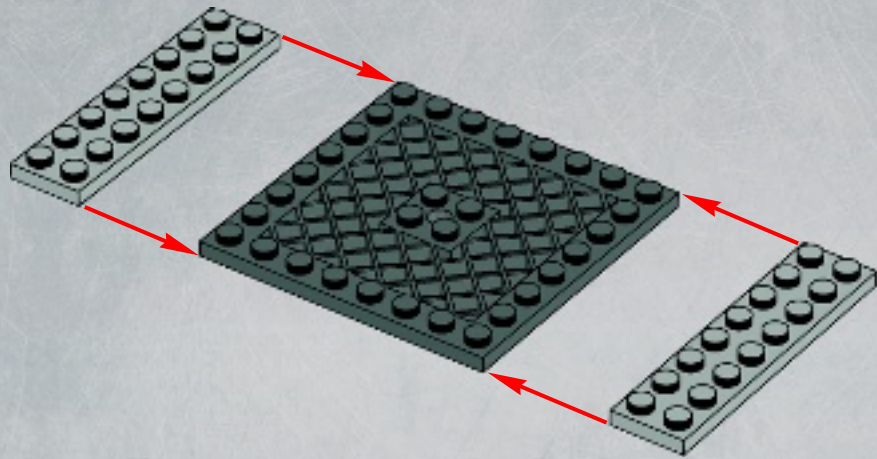

2

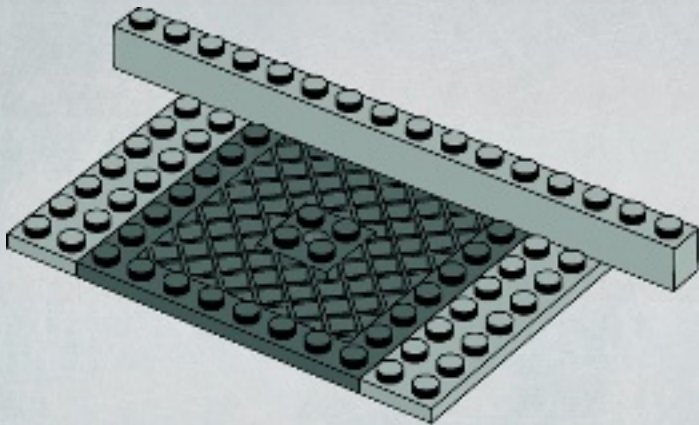

3

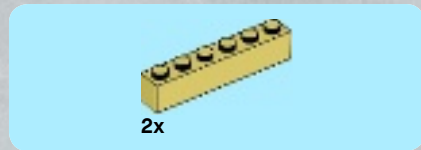
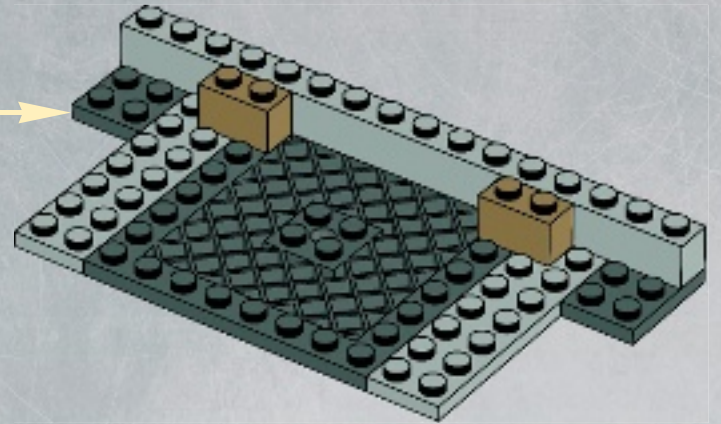

4

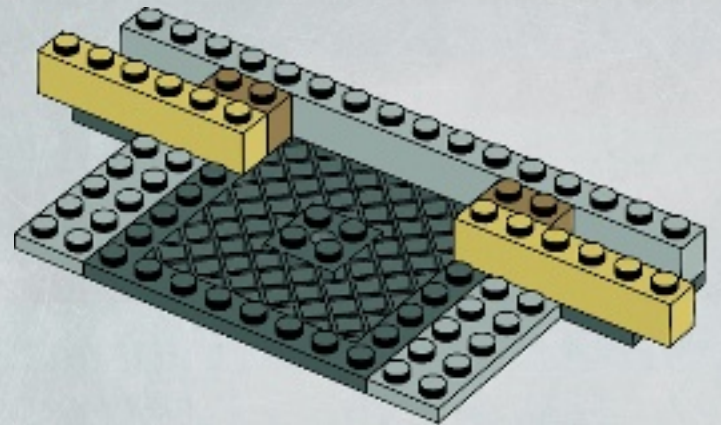



5

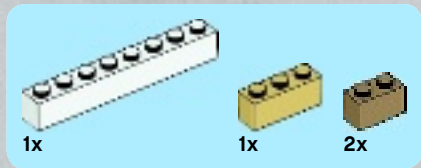
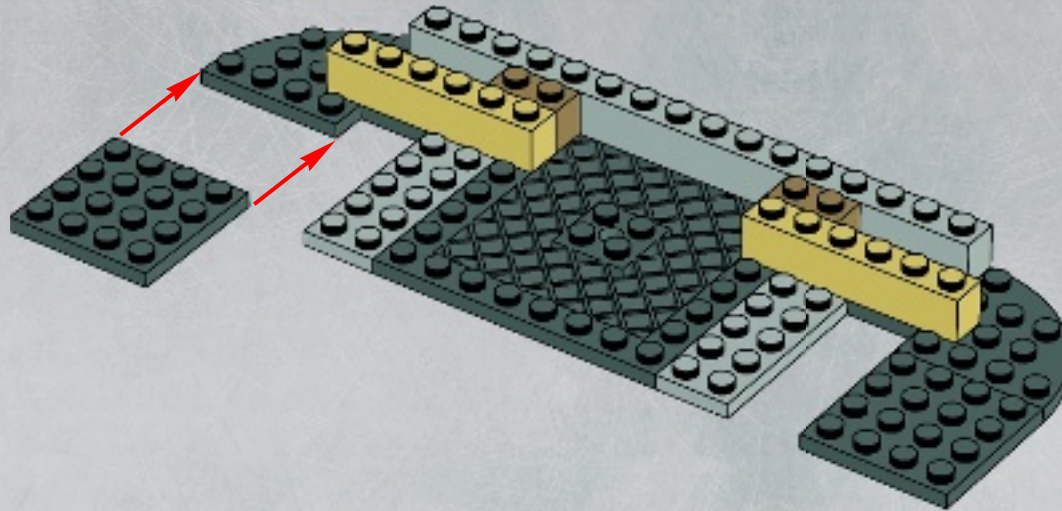

6

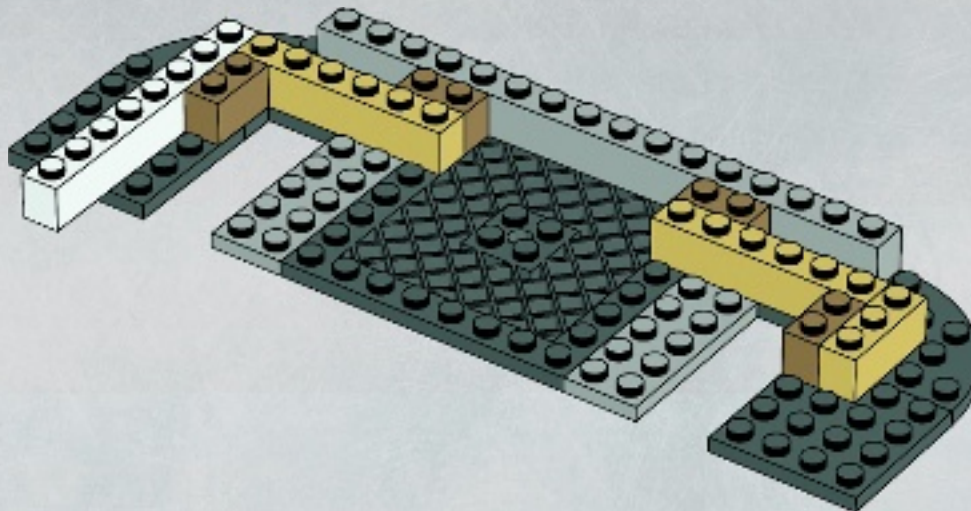

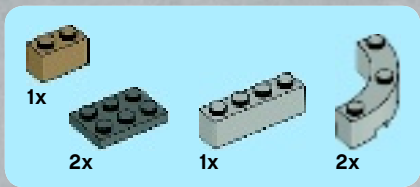

7

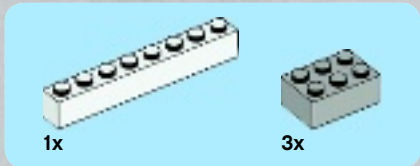
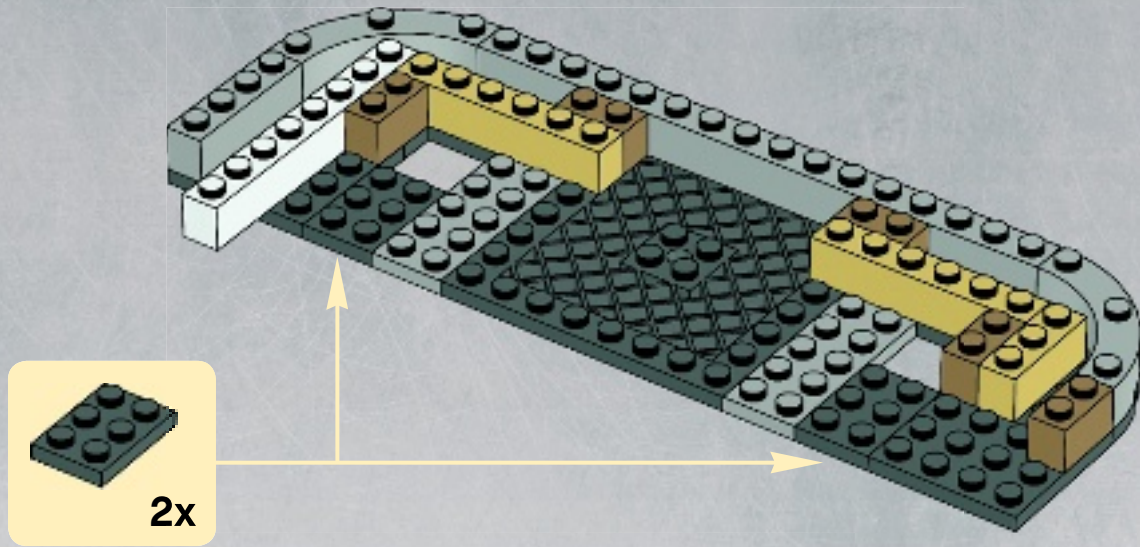

8

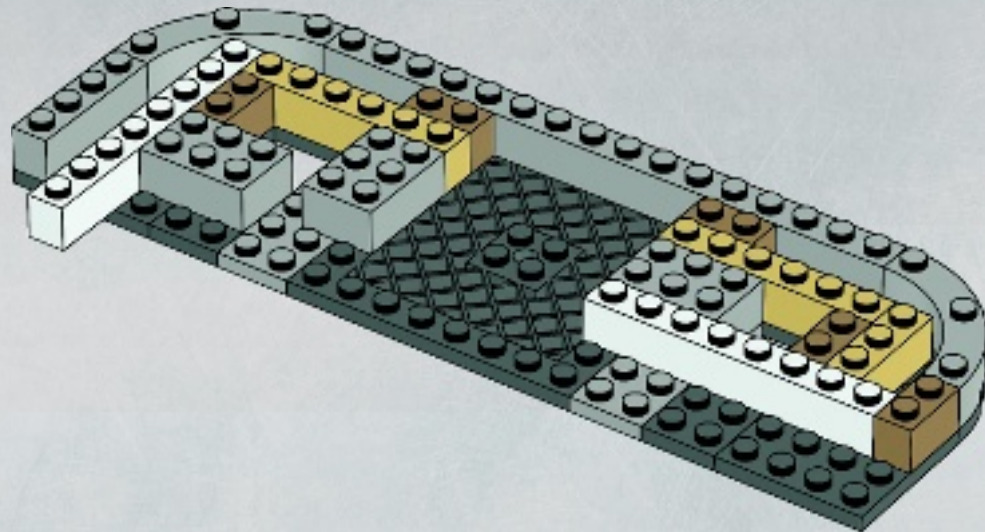

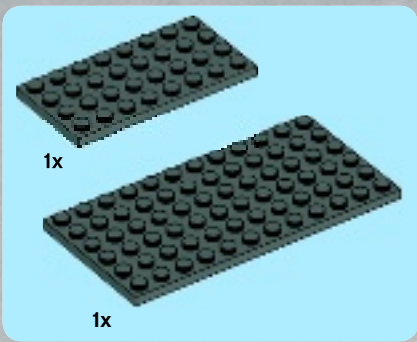

9

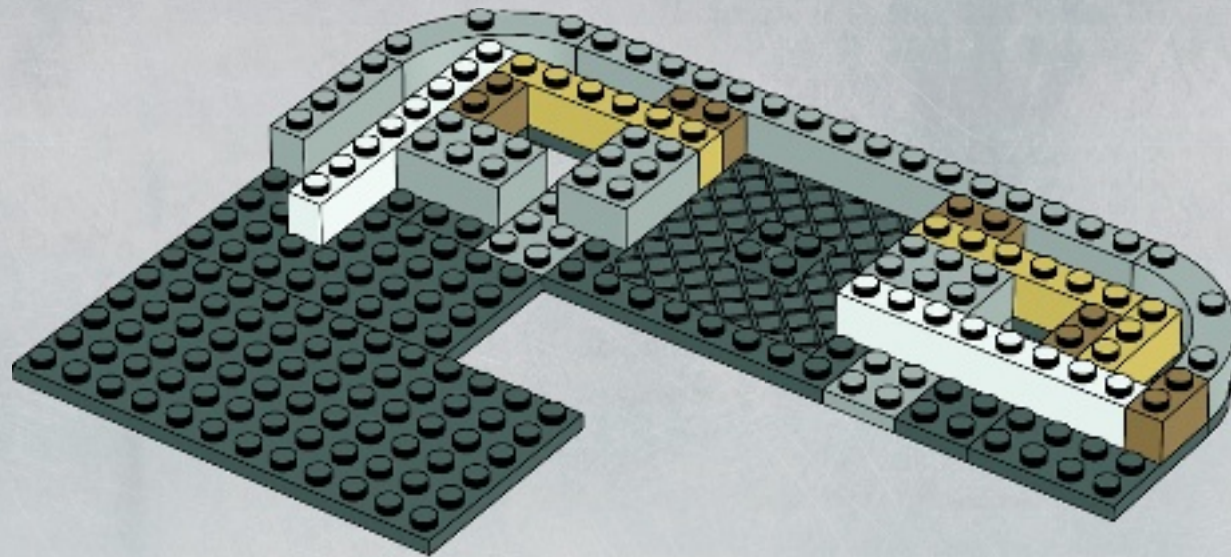

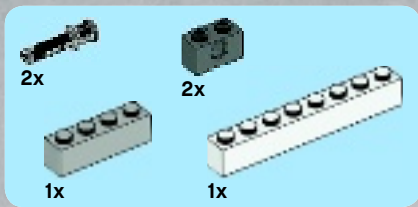

10

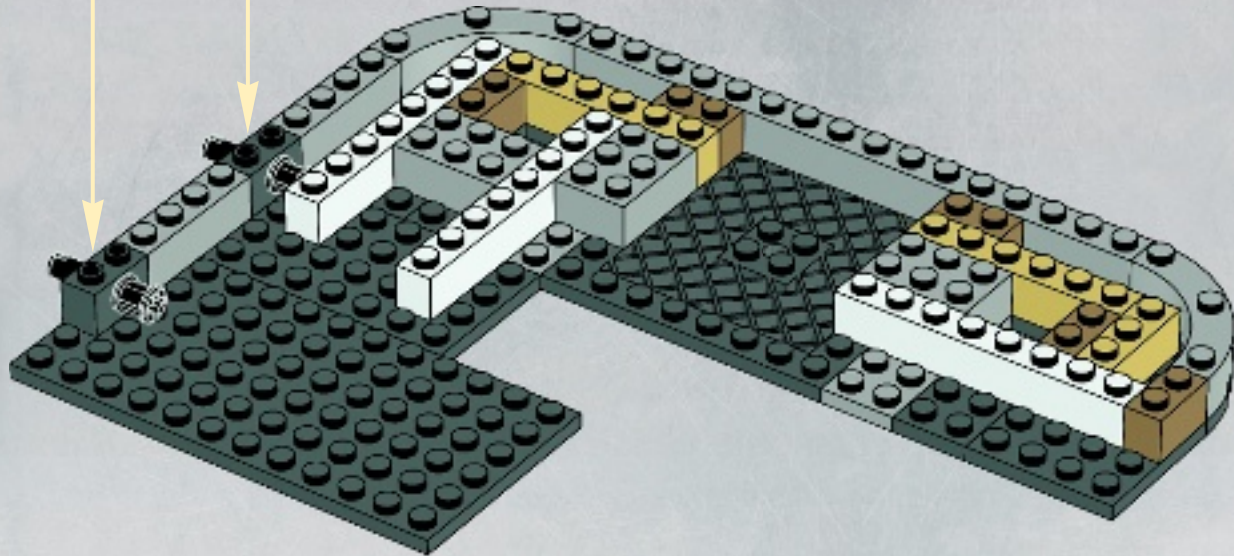
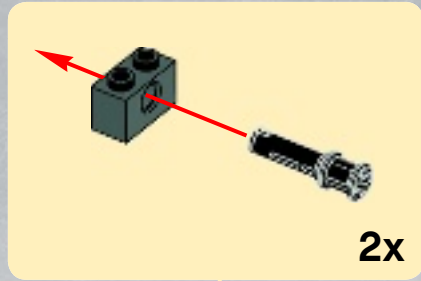

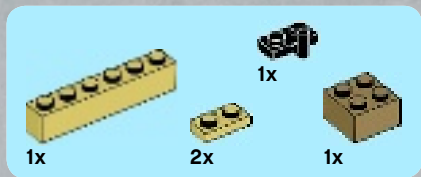

11

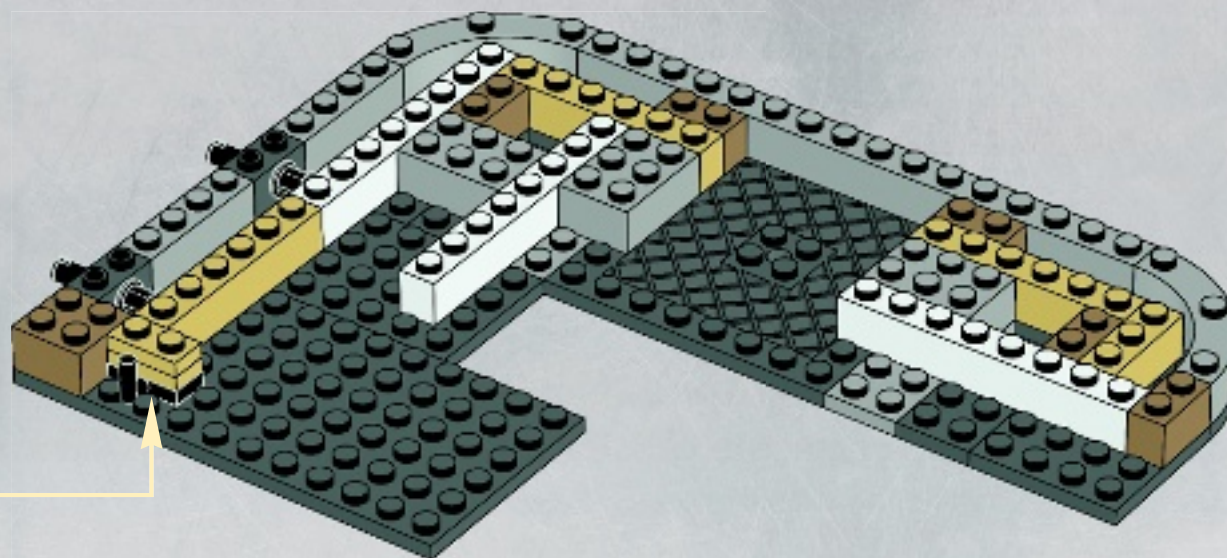
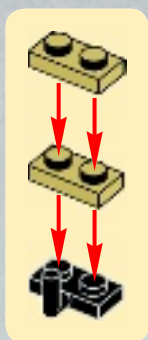

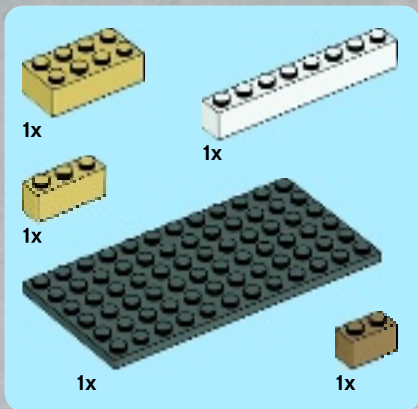

12

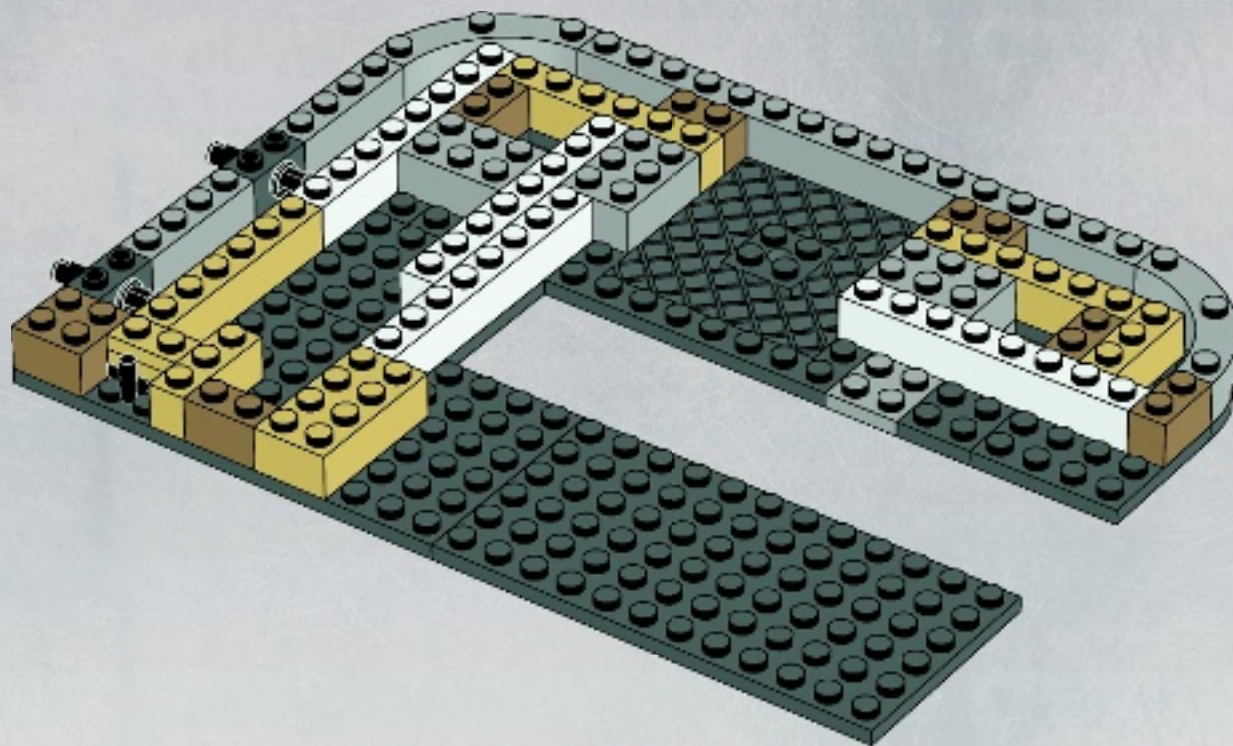

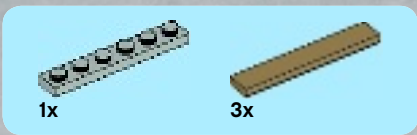

13

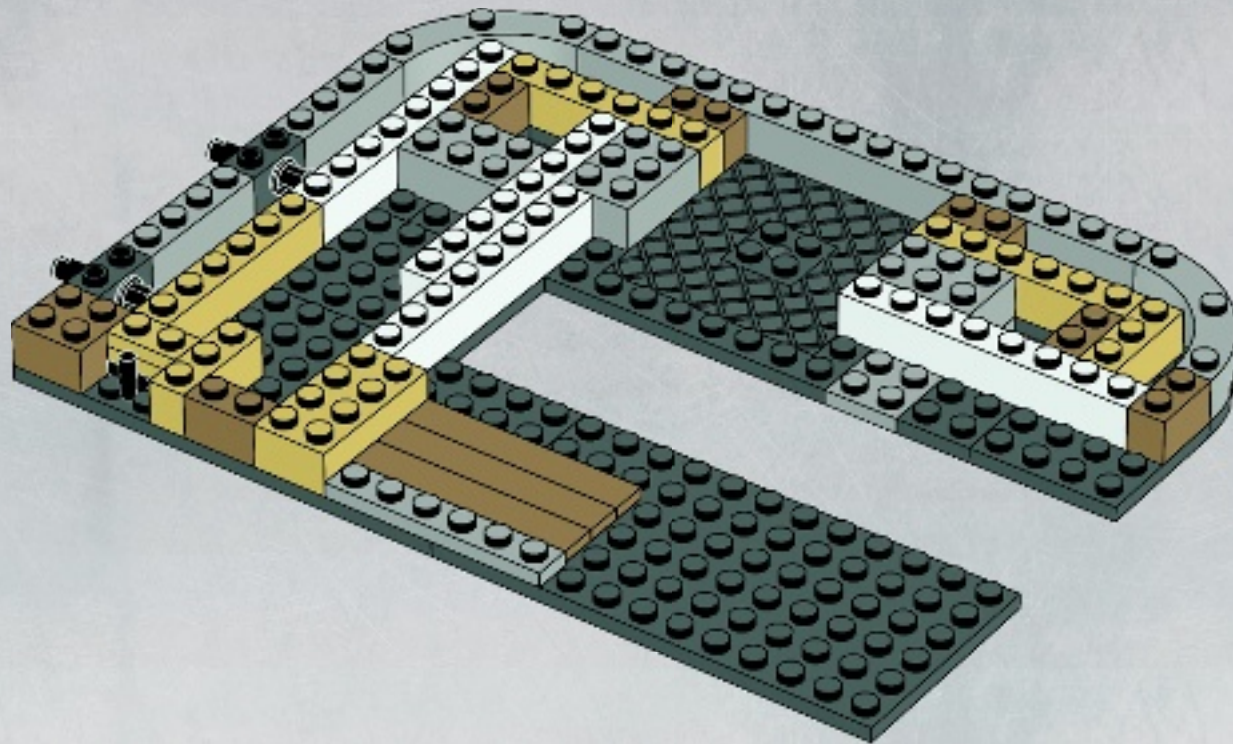

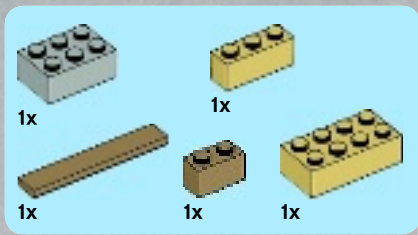

14

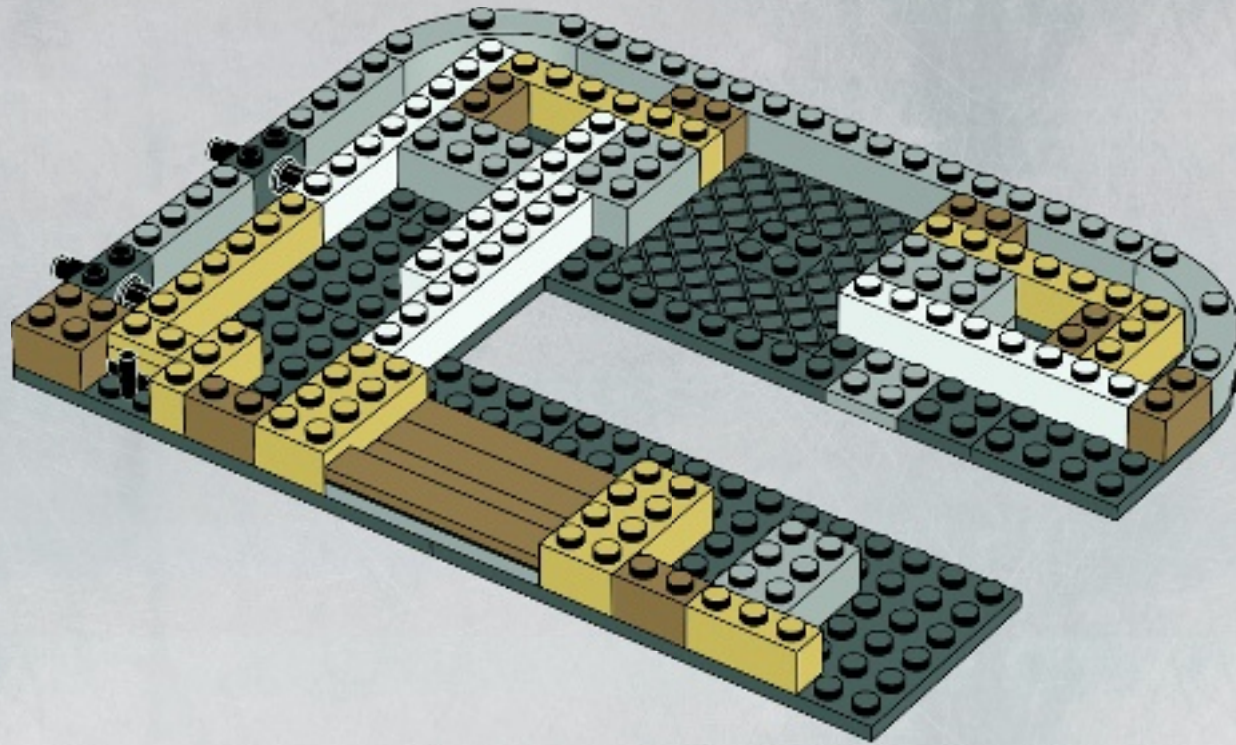



8x



1x

15

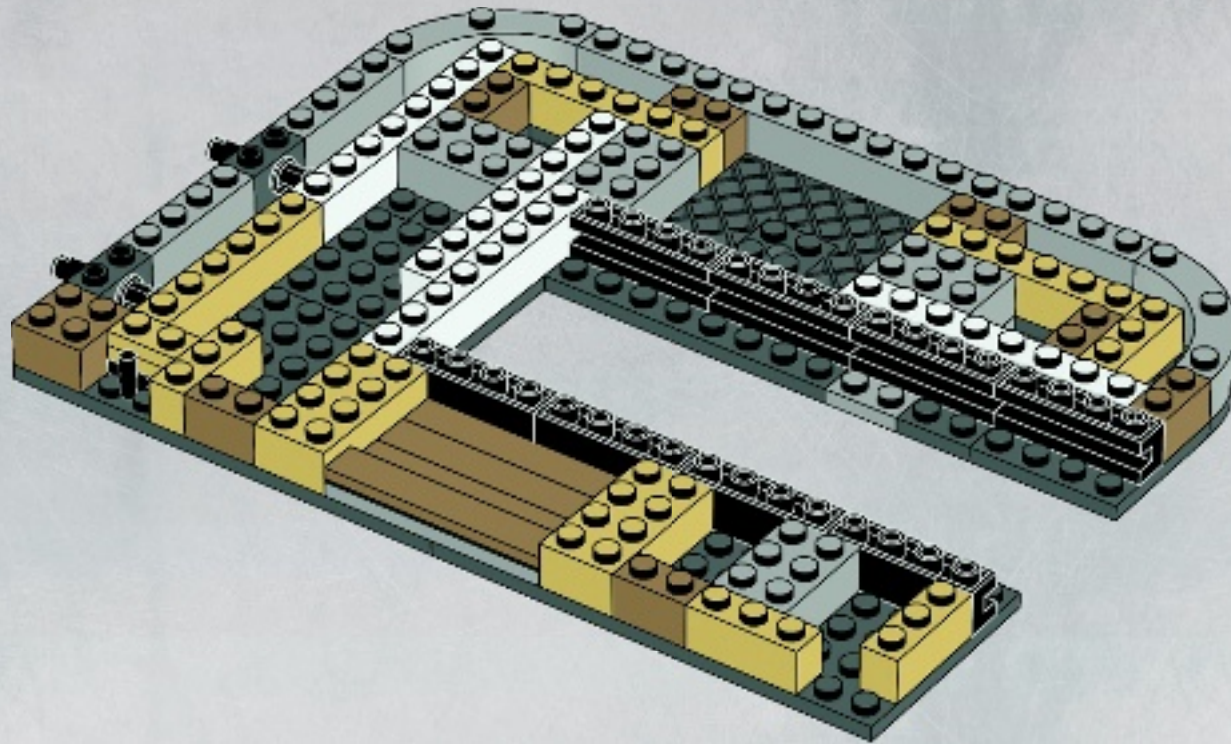



16

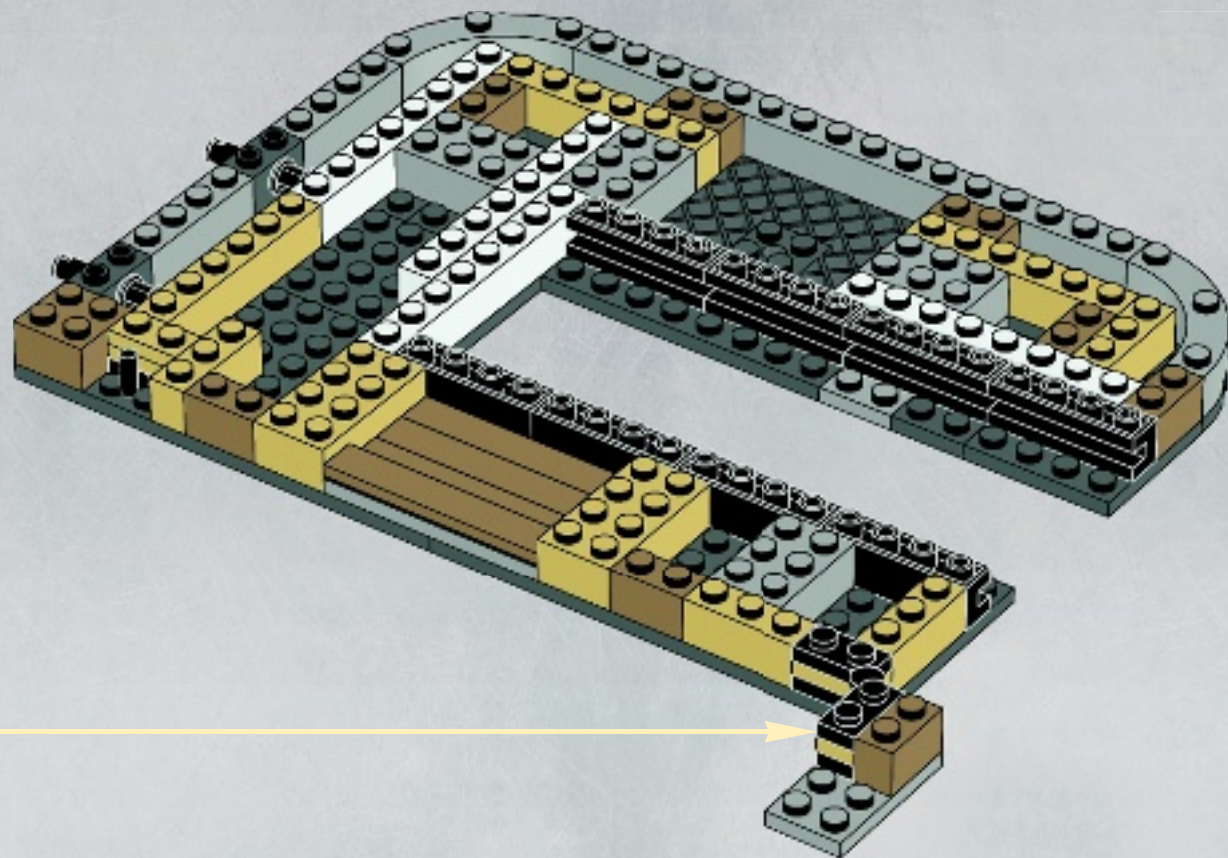
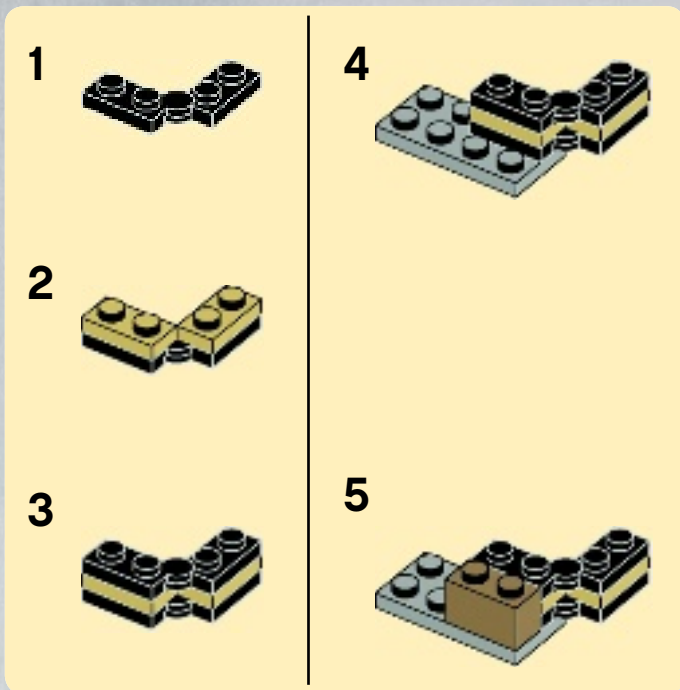

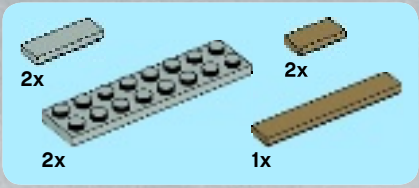
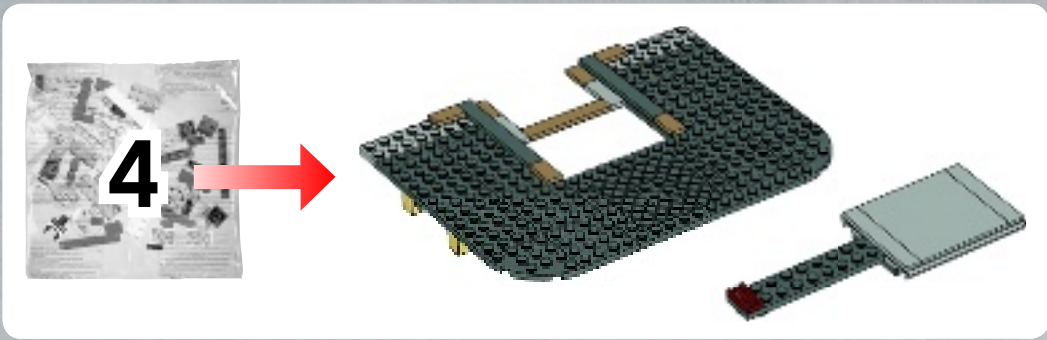

17

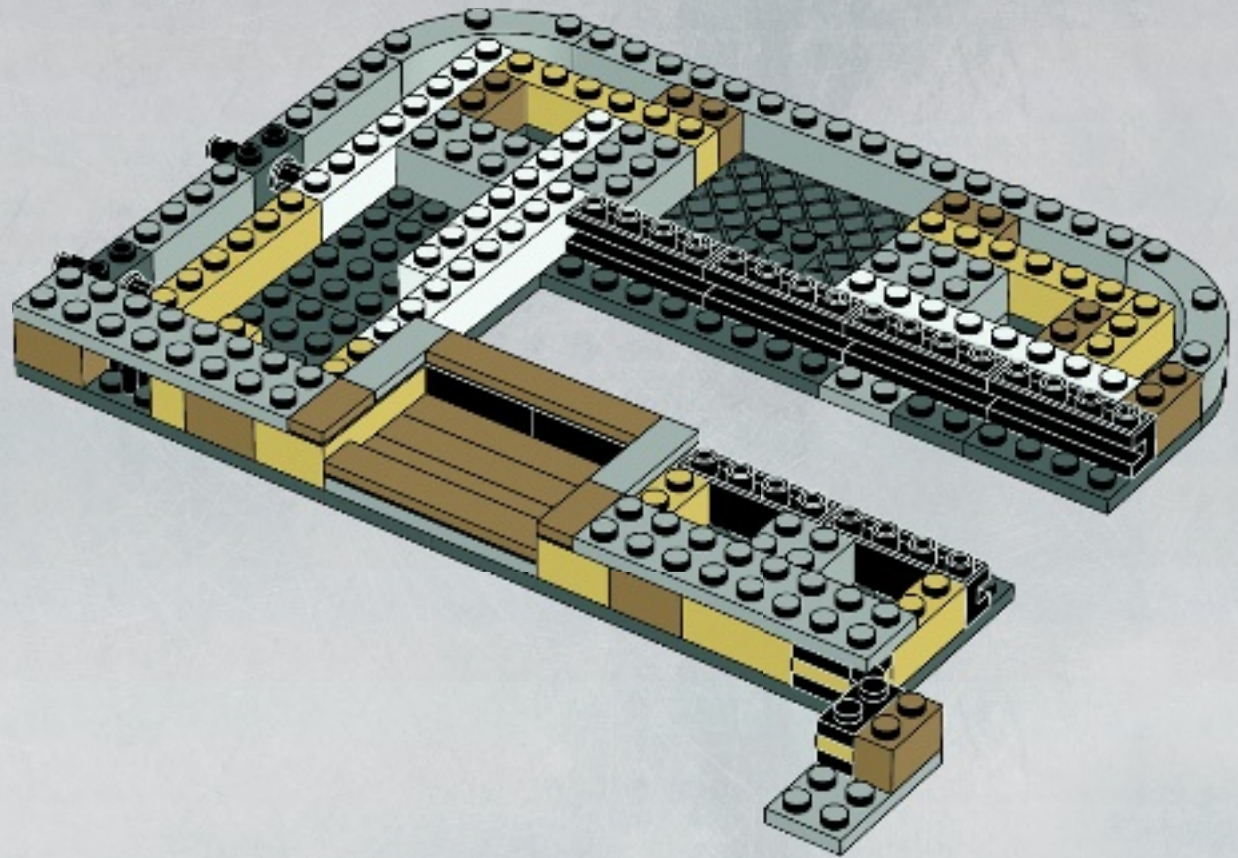



1

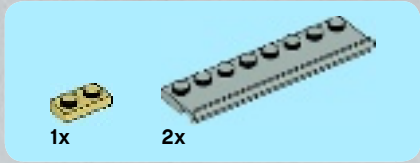
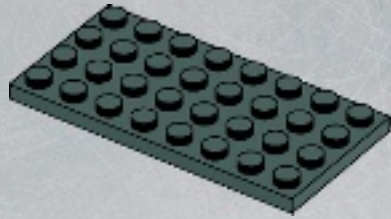

2

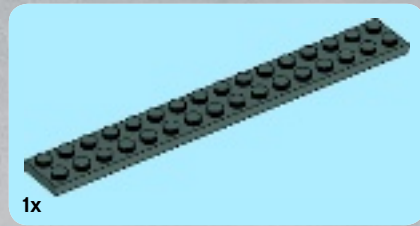
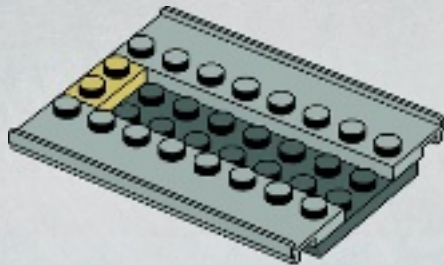

3

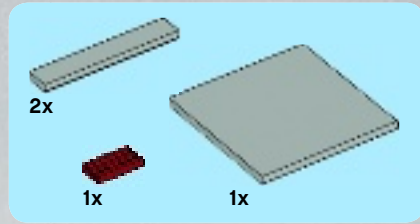
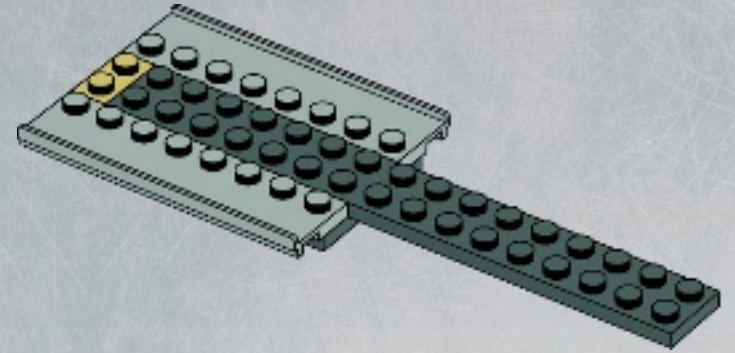

4

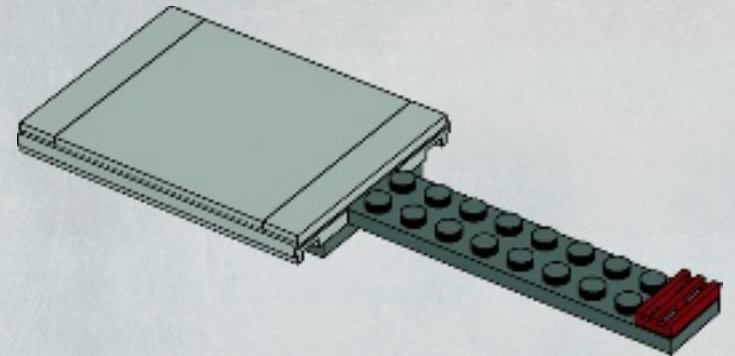



1x

5

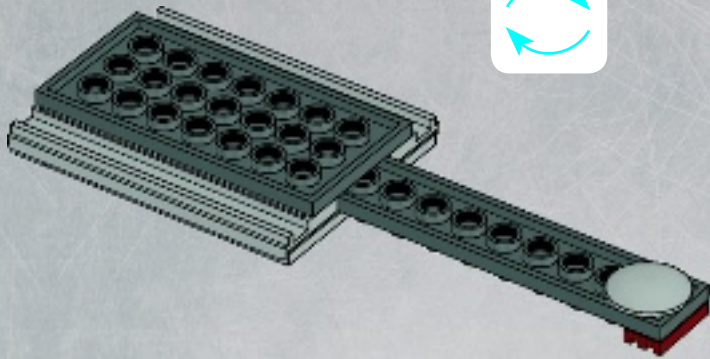

6

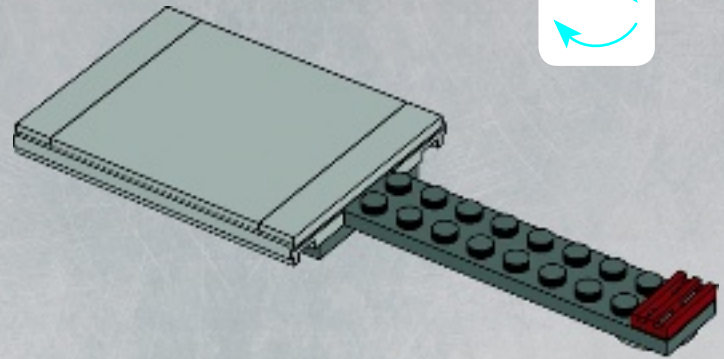

18

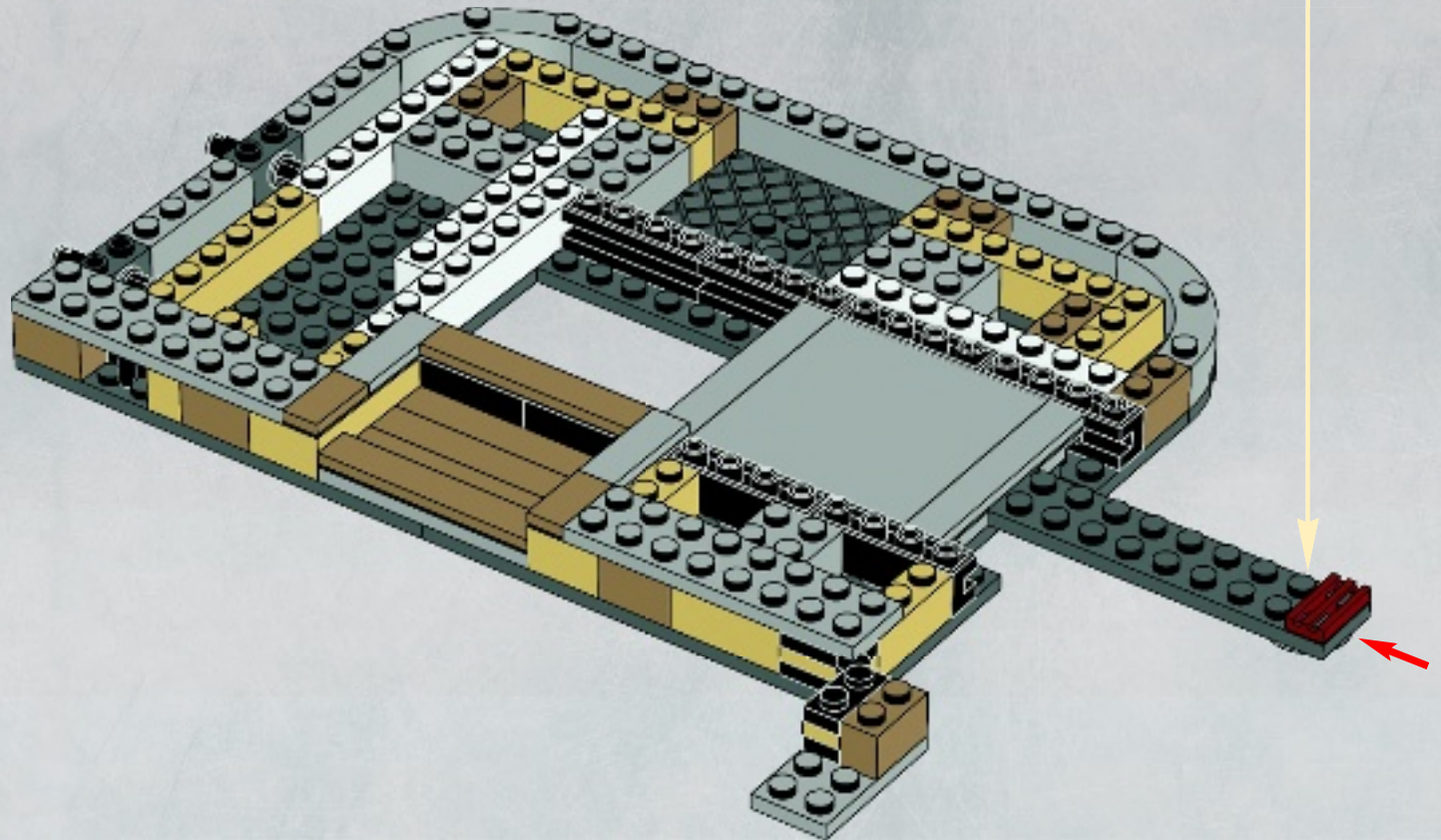



2x

19

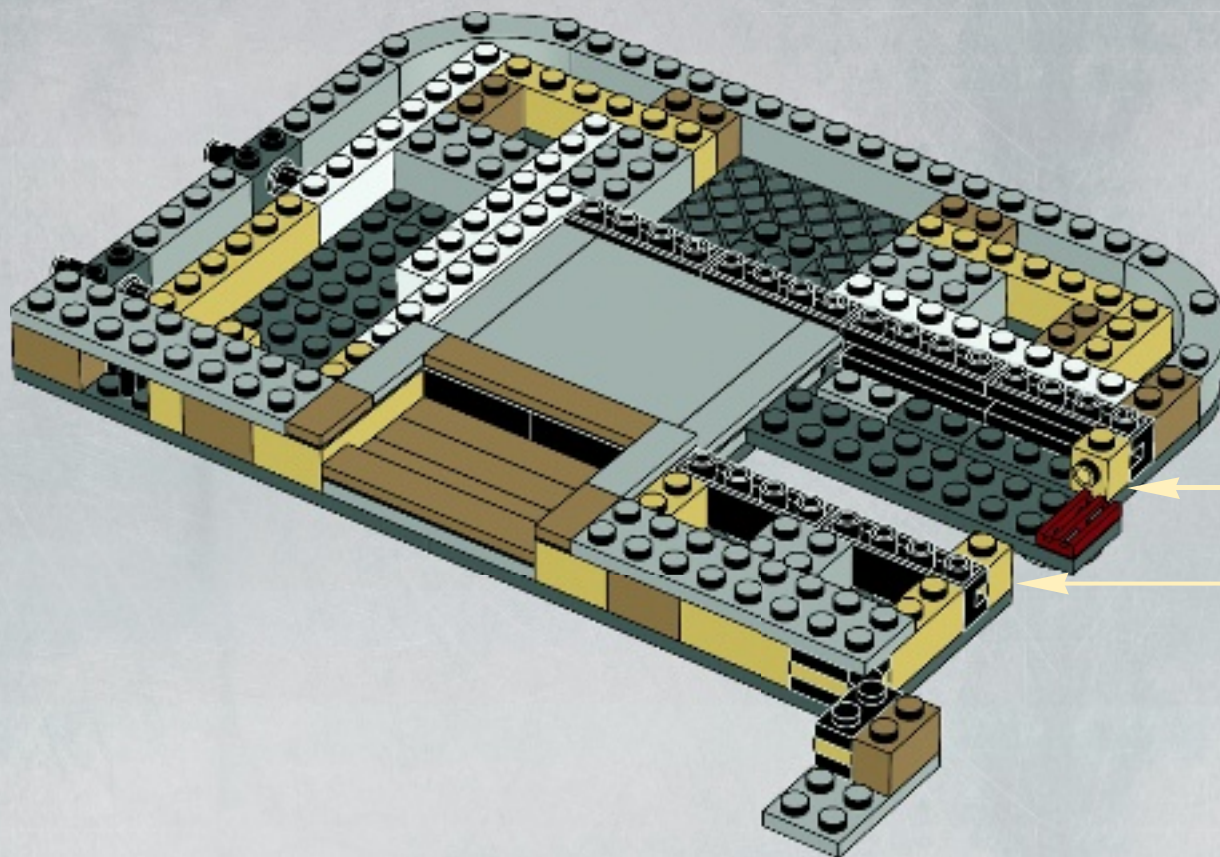

2x



4x

20

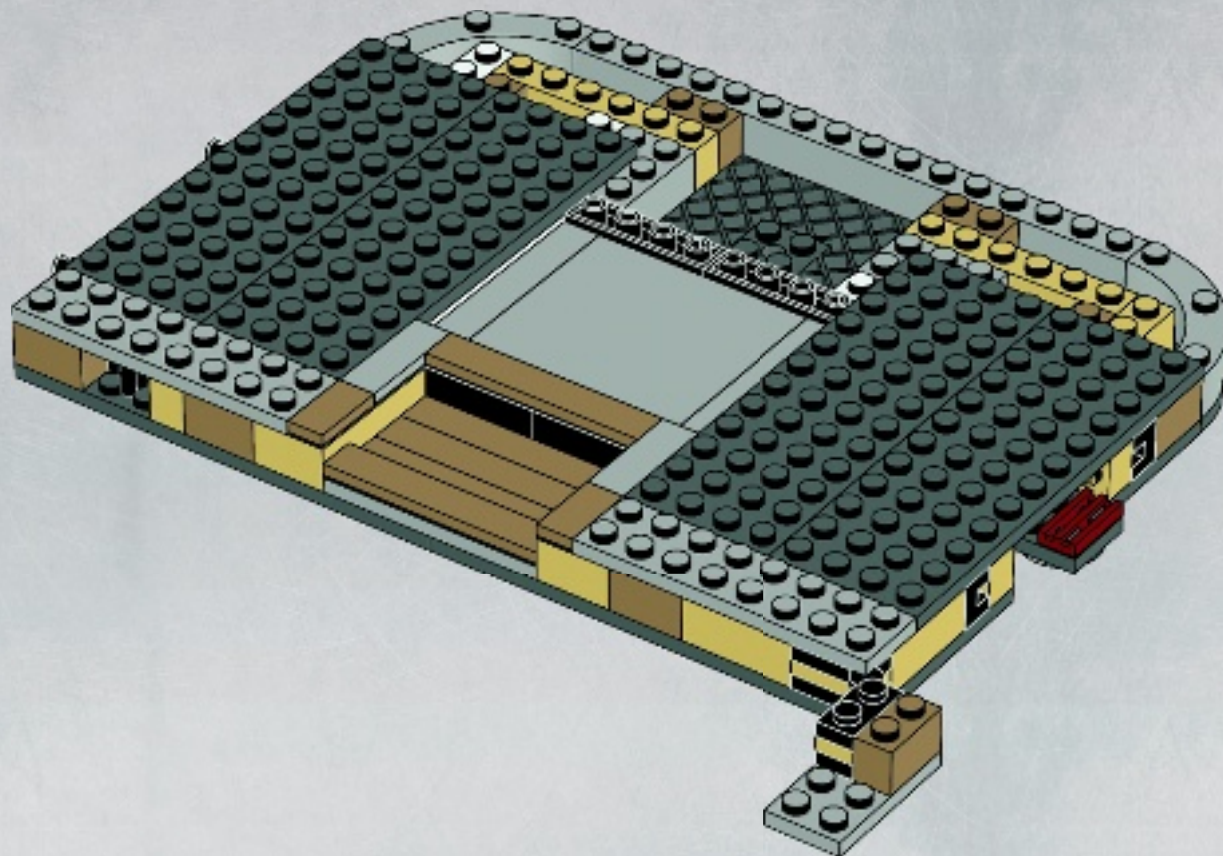

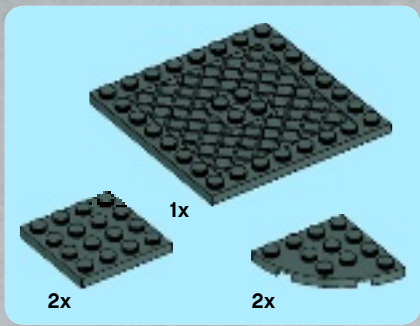

21

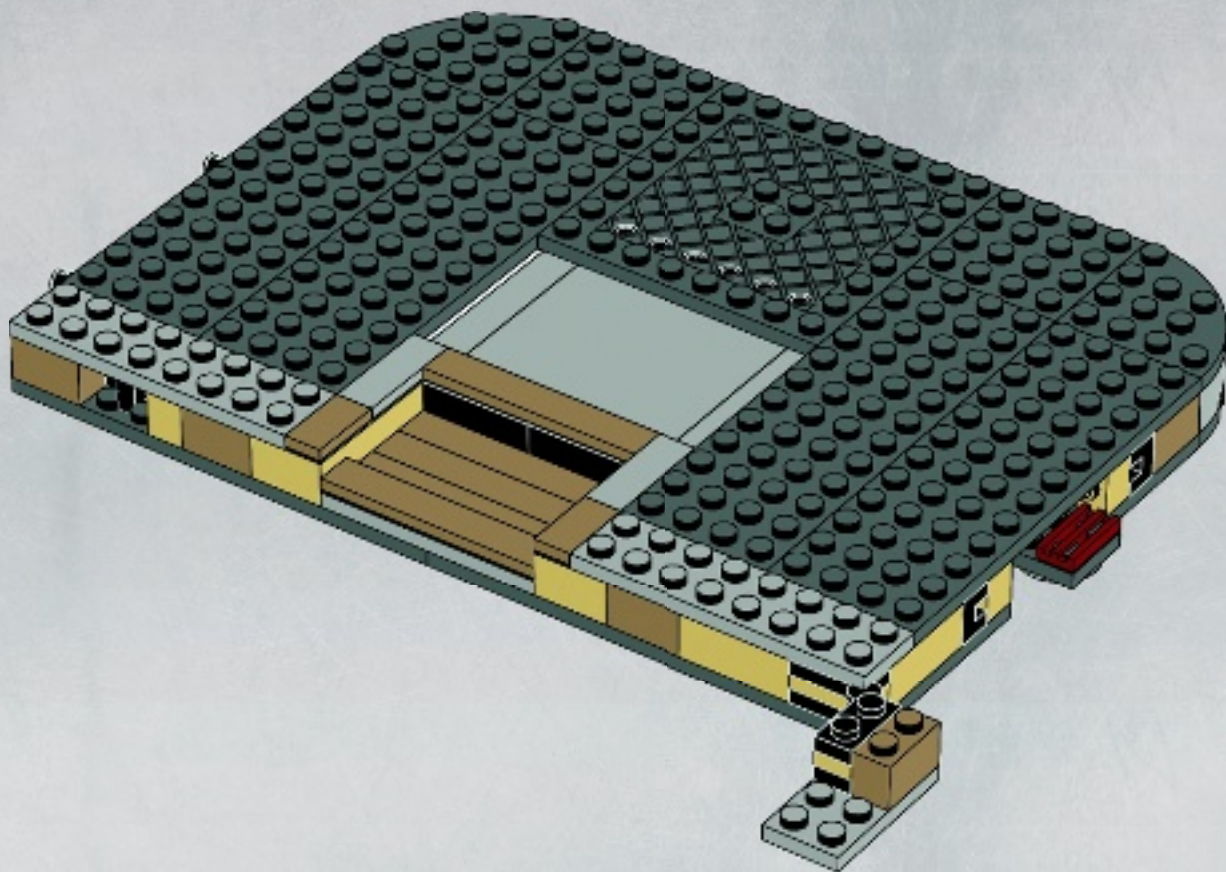



22

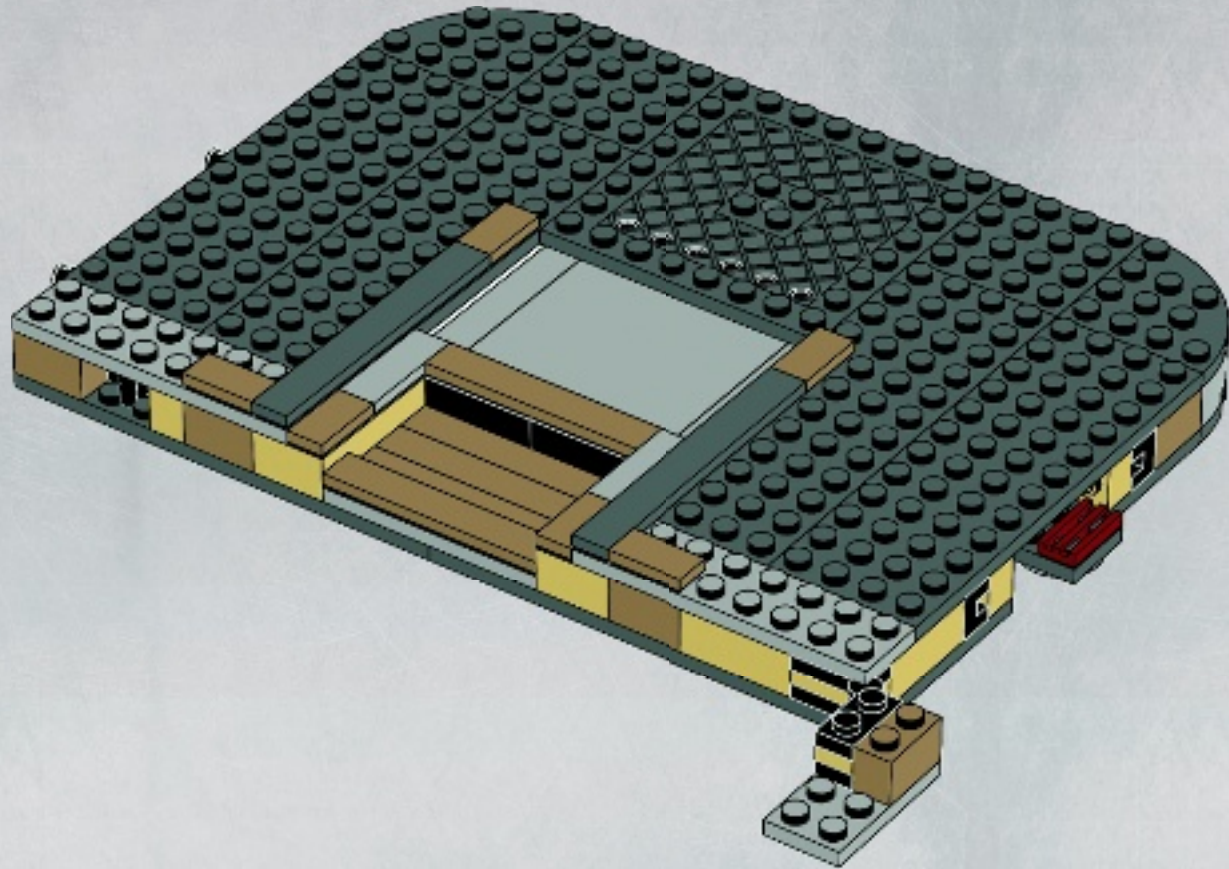

5



3x



2x



1x

23

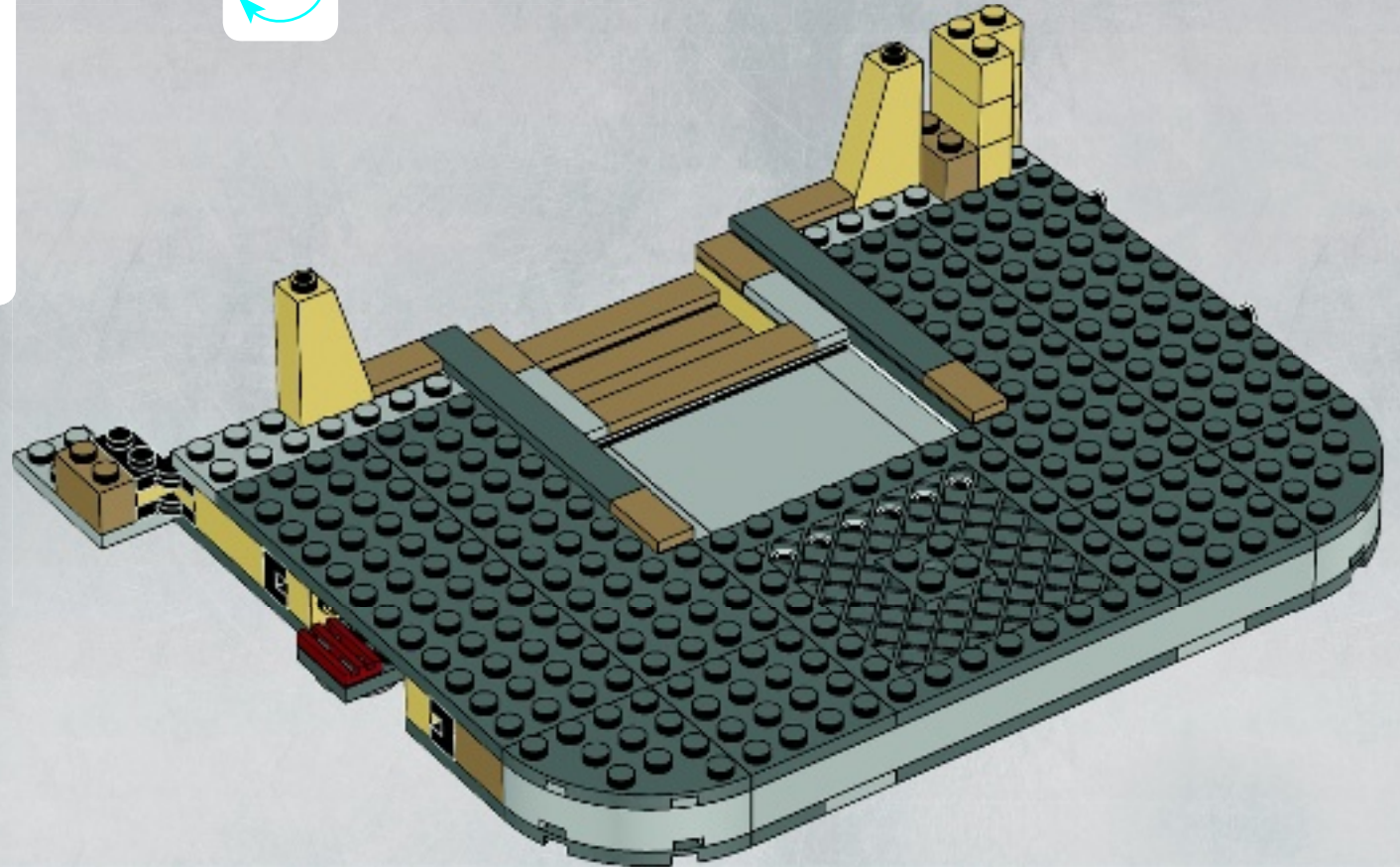
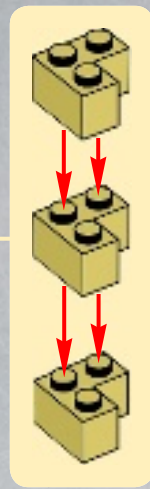



24

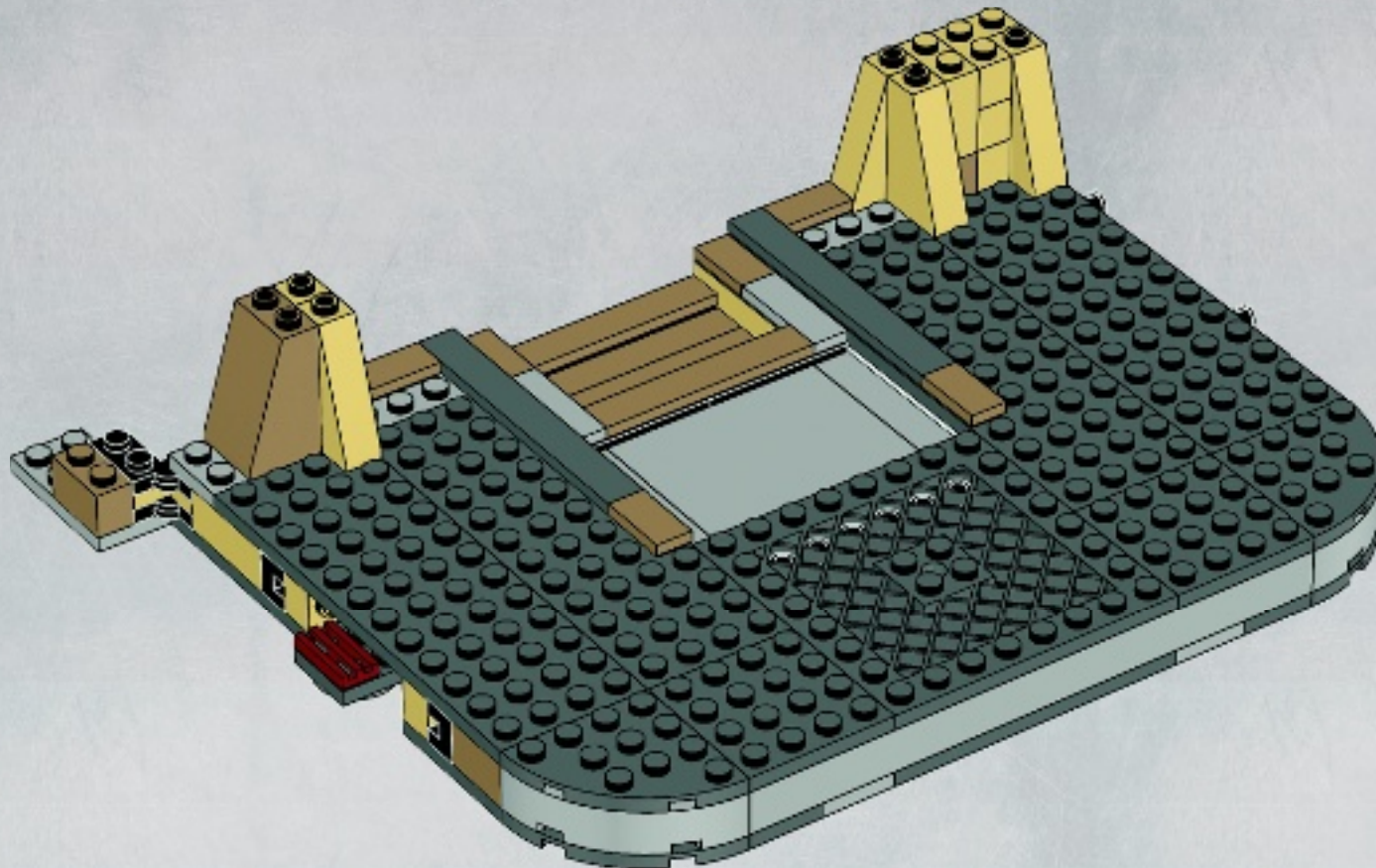

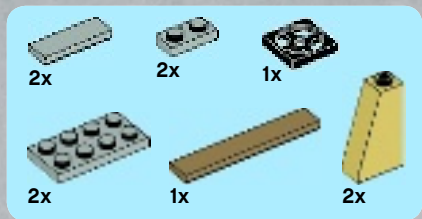

25

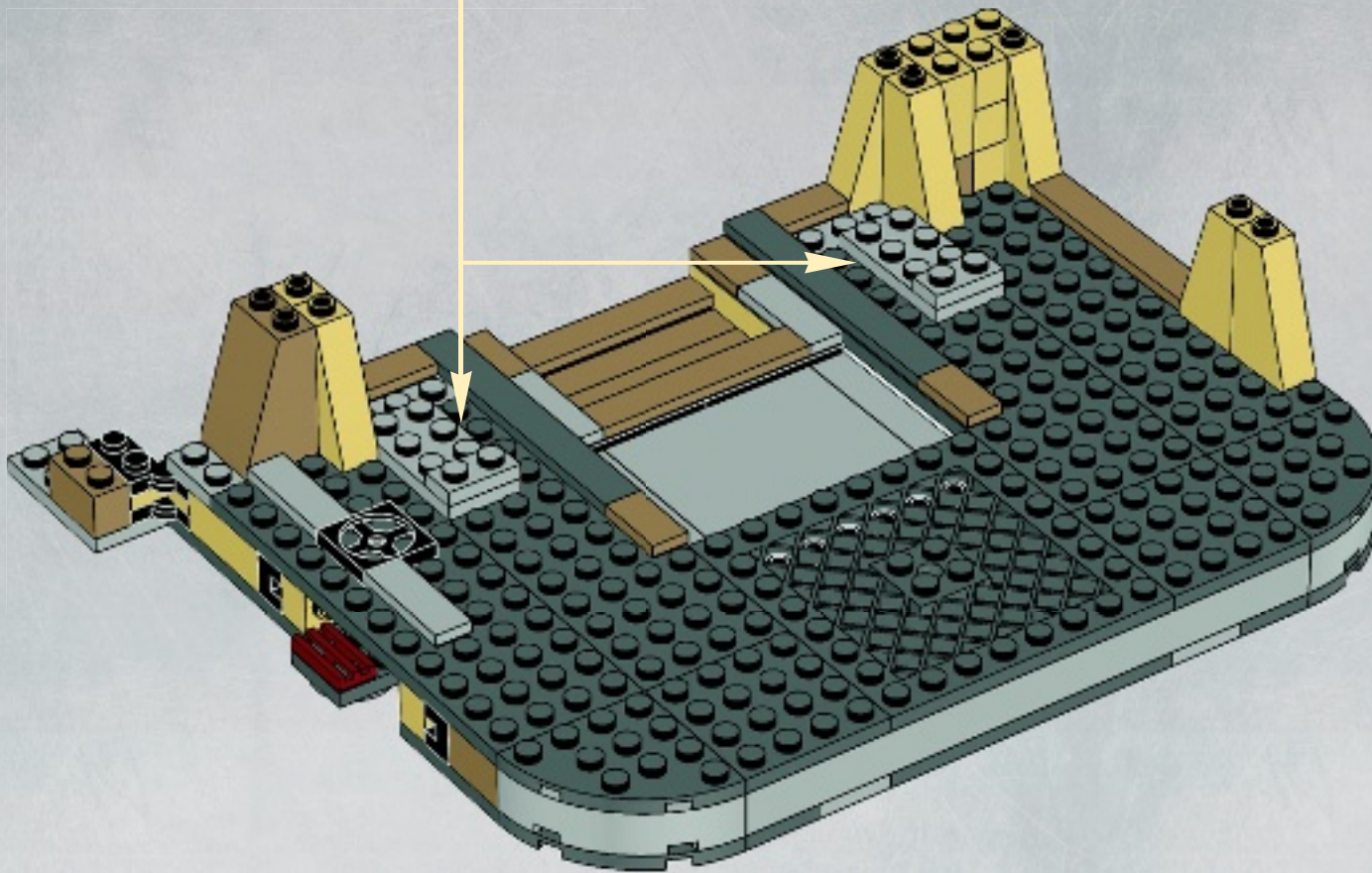
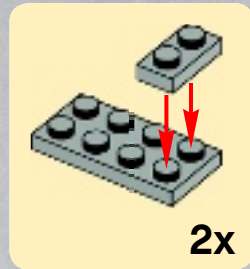



26

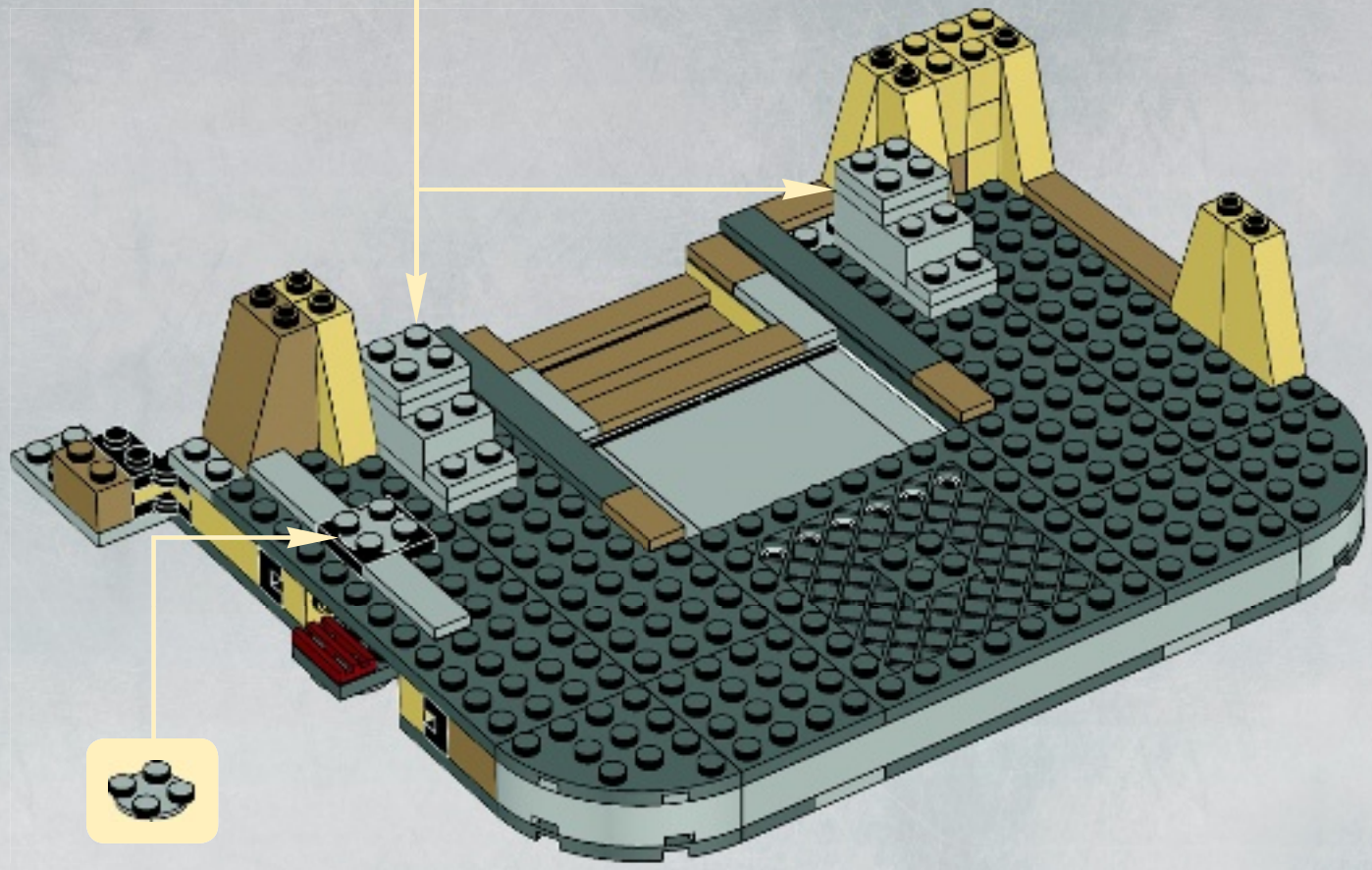
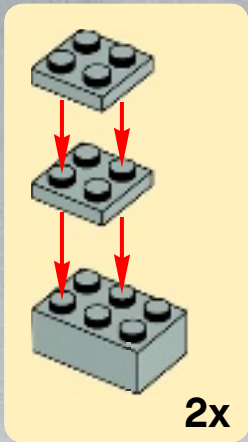



27

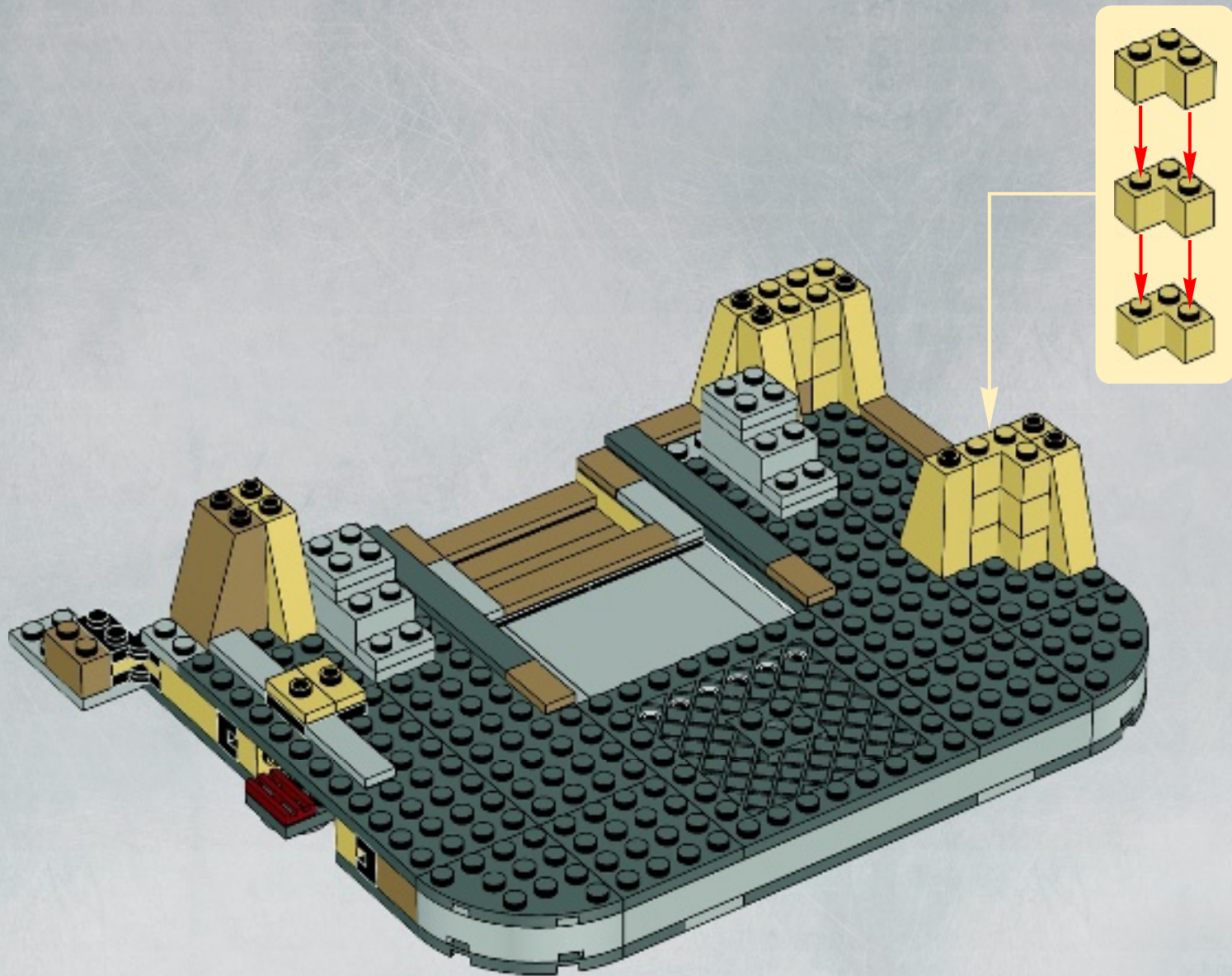

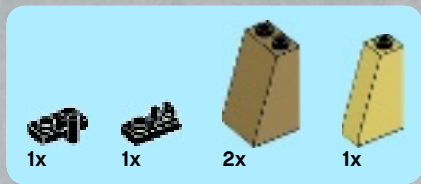

28

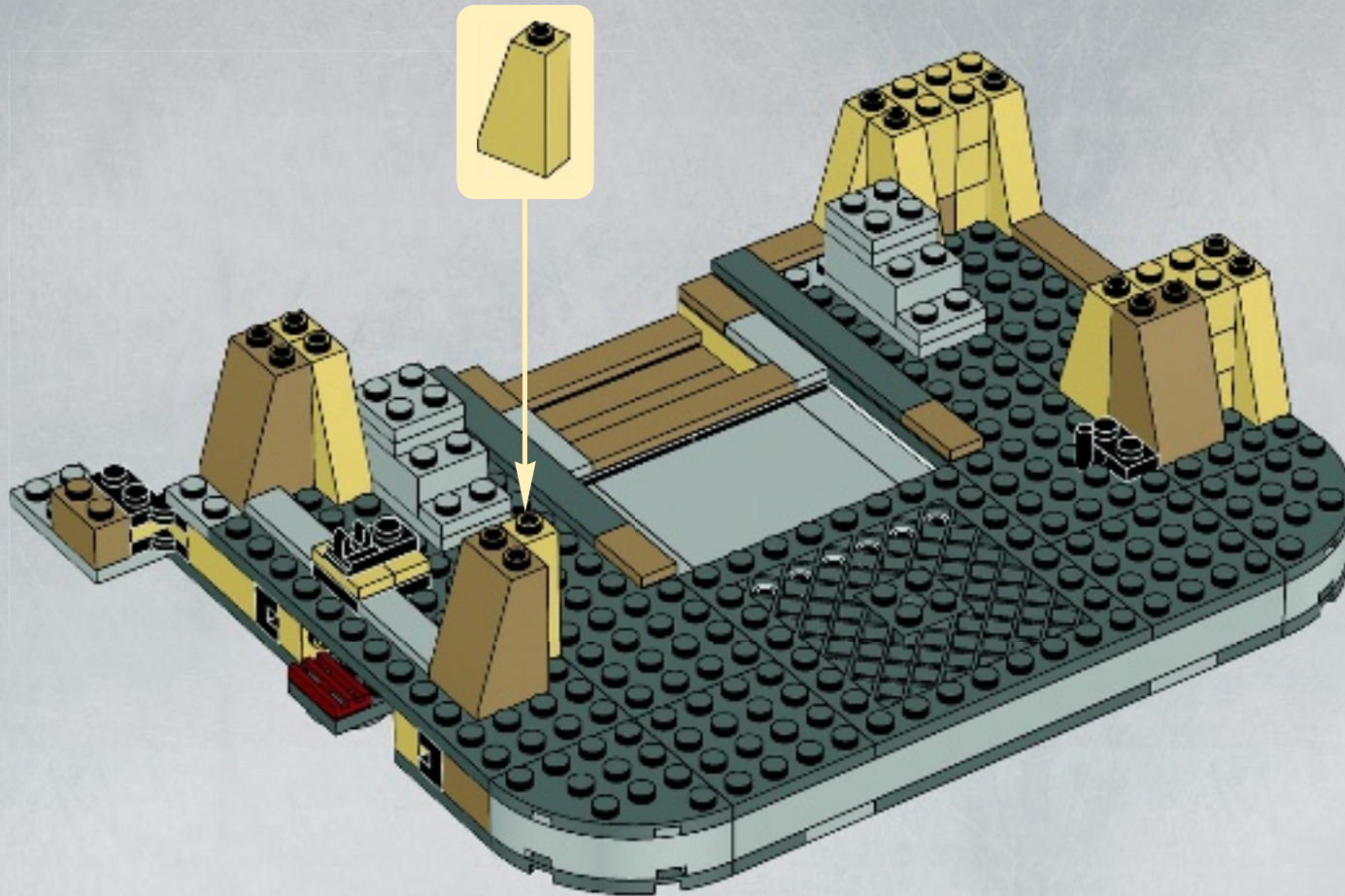

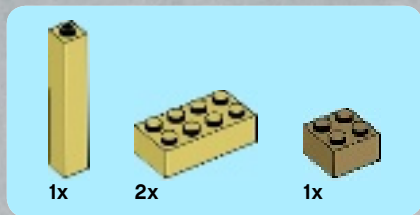

29

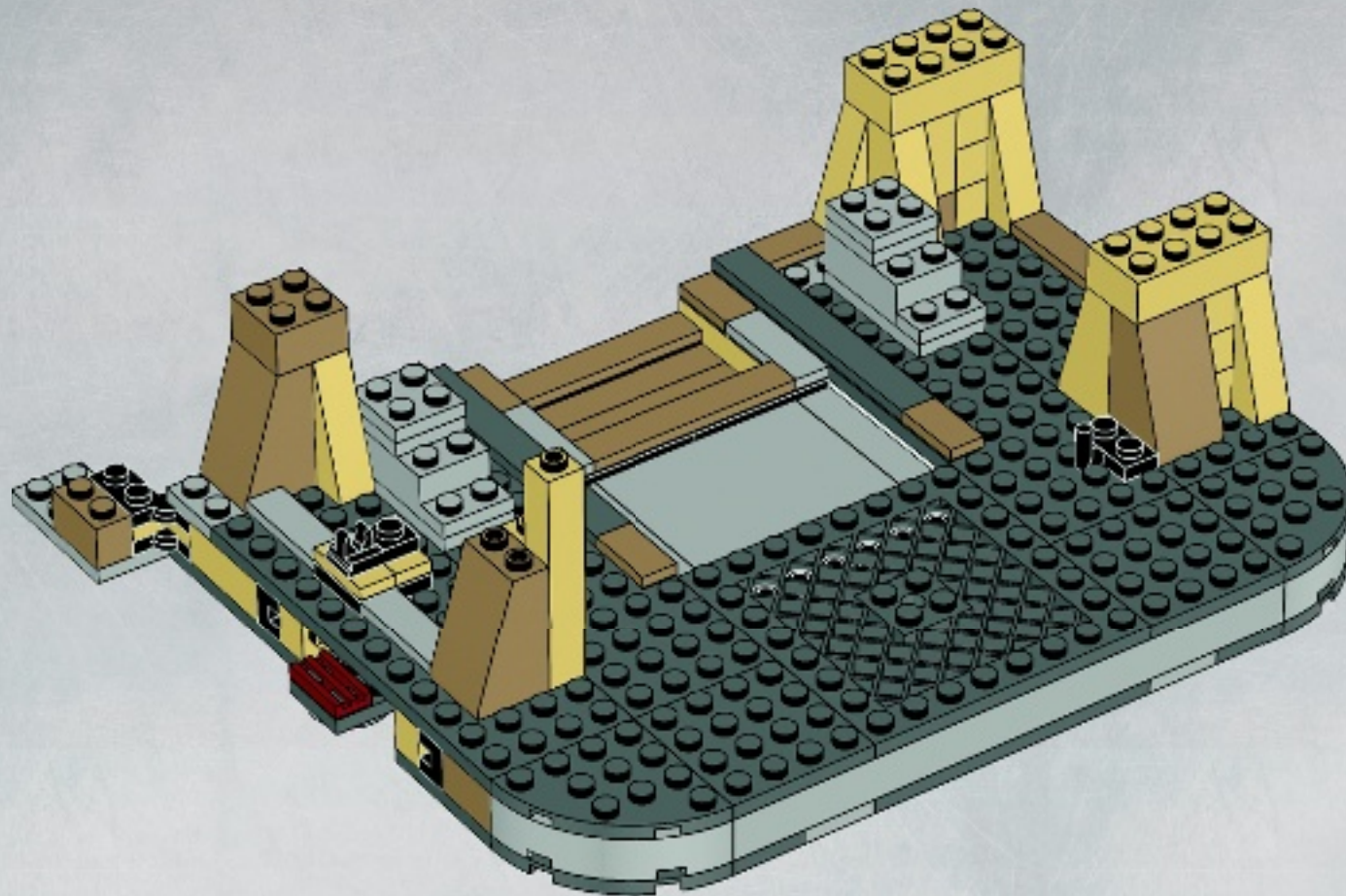

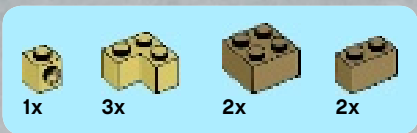

30

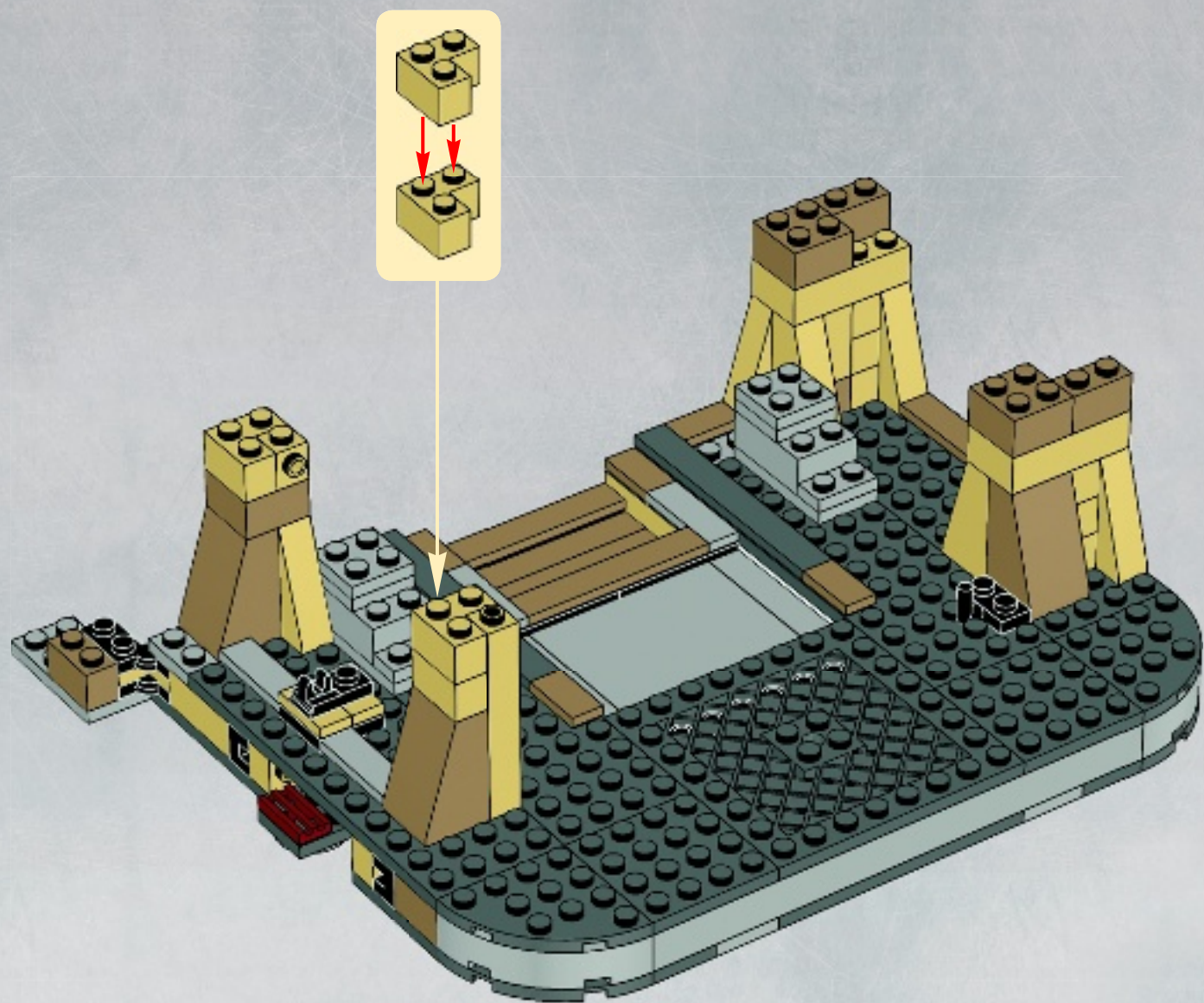

- 2x
- 4x
- 1x
- 4x

31

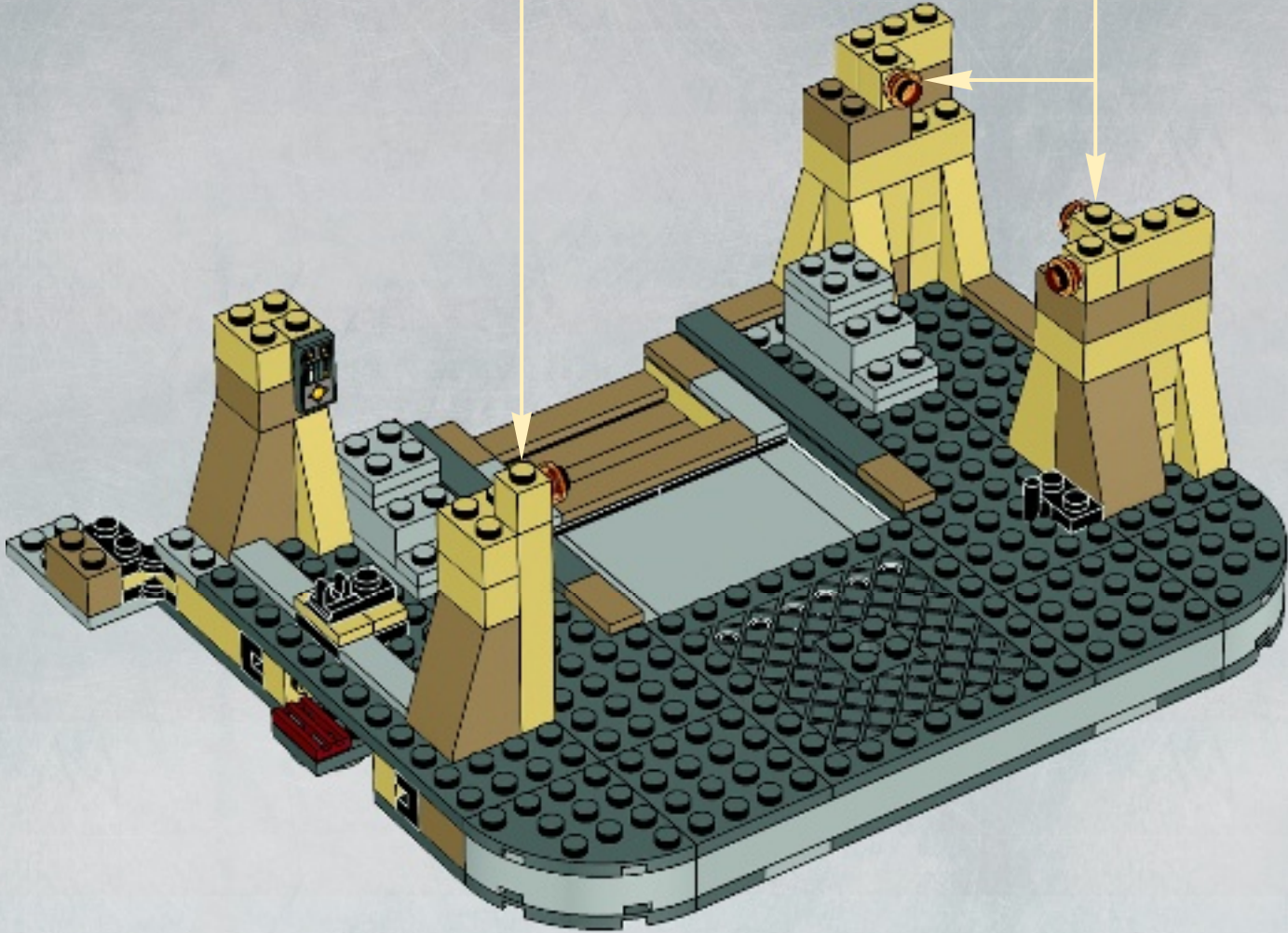
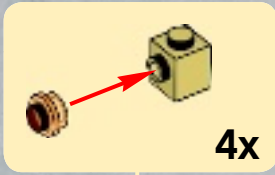

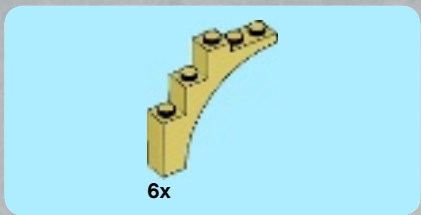

32

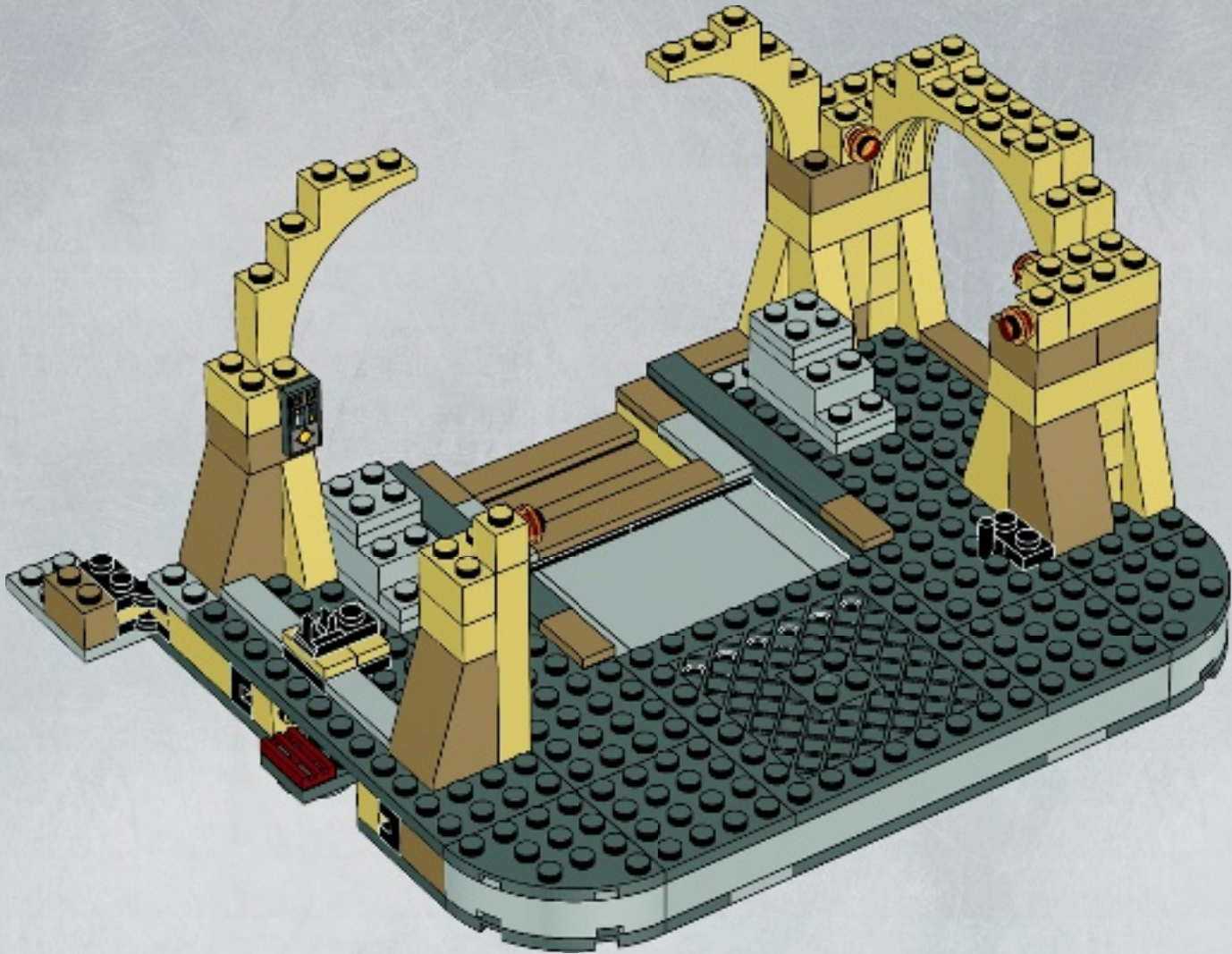

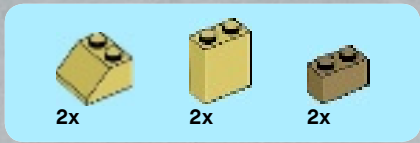

33

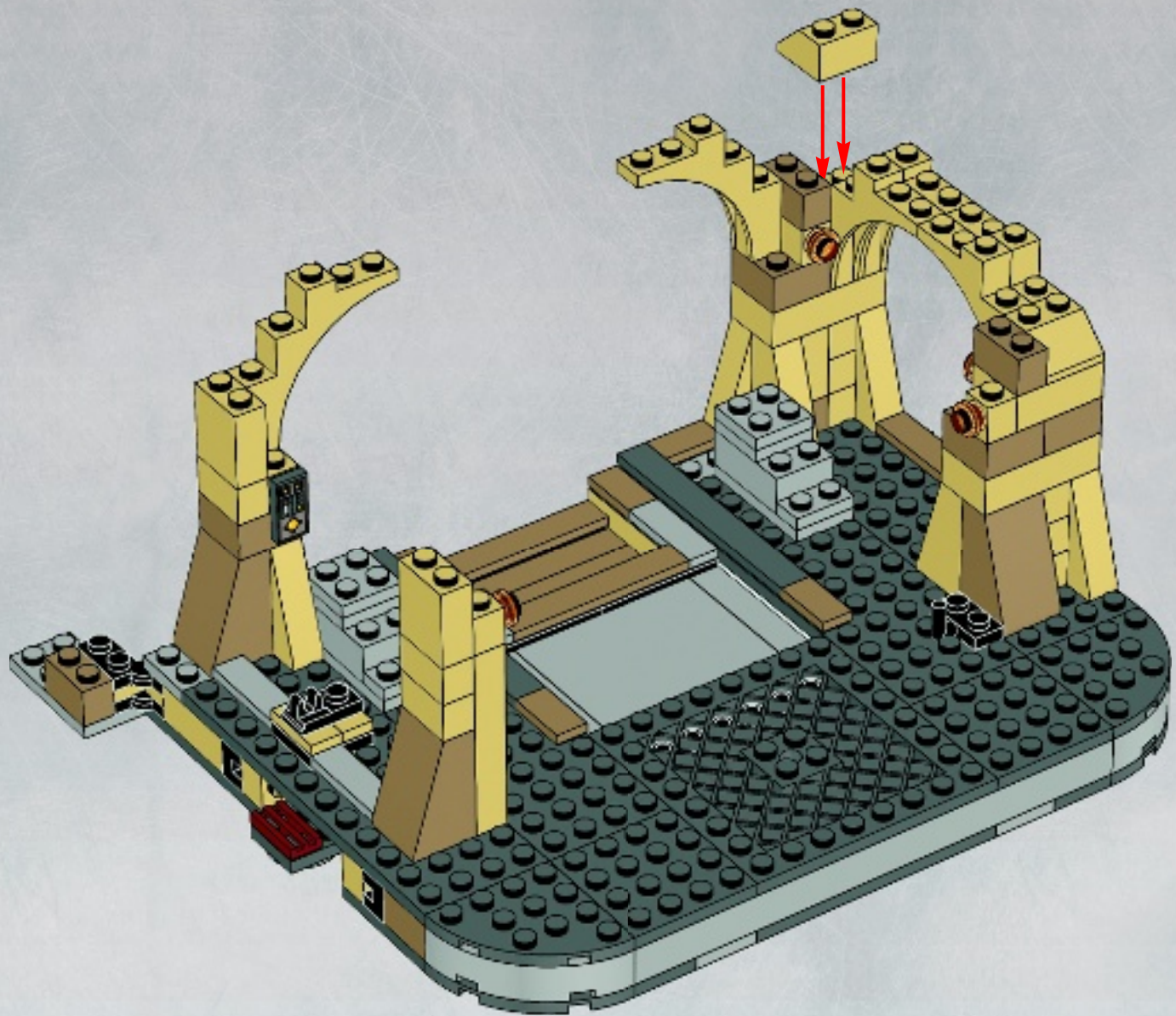

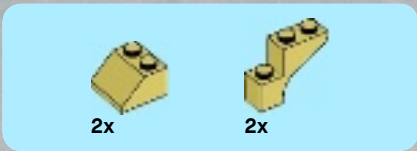

34

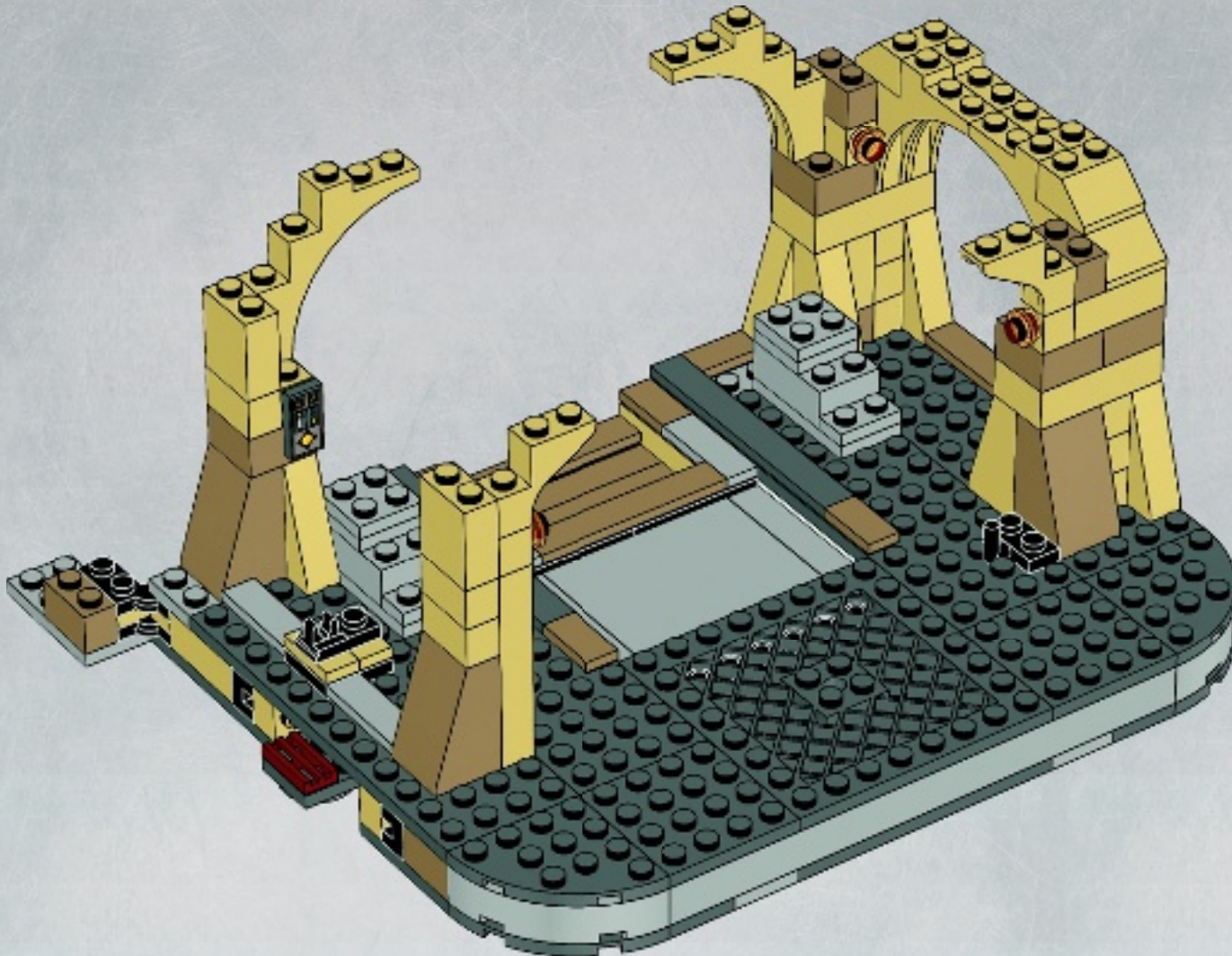



2x



2x



2x

35

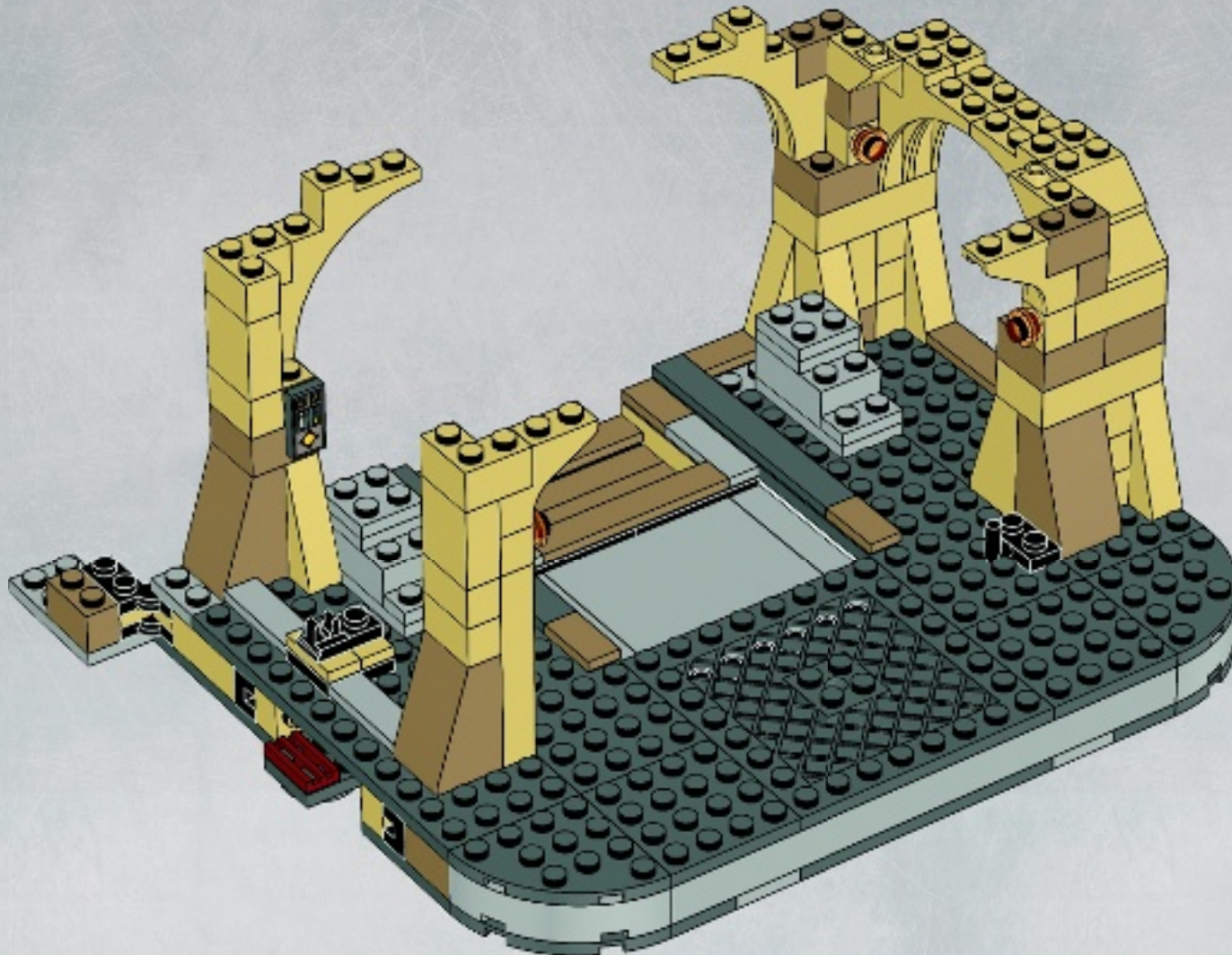

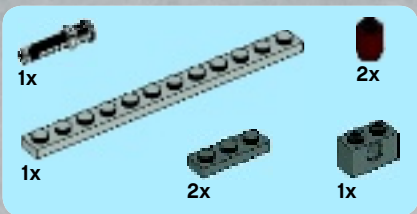

36

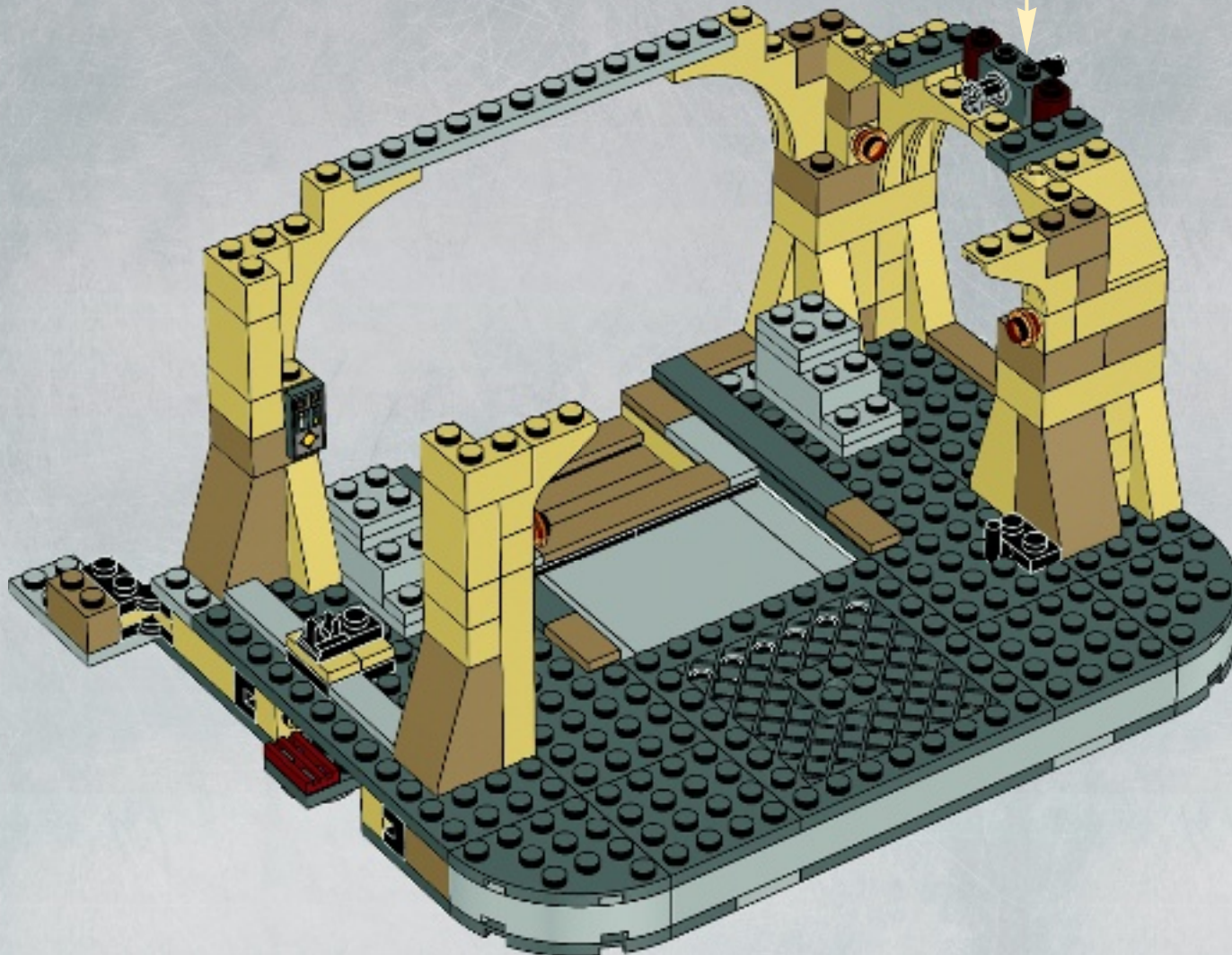
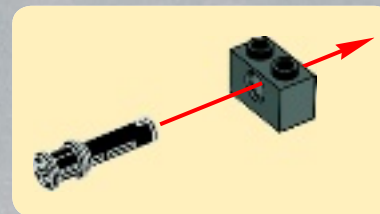

4x

2x

1x

37

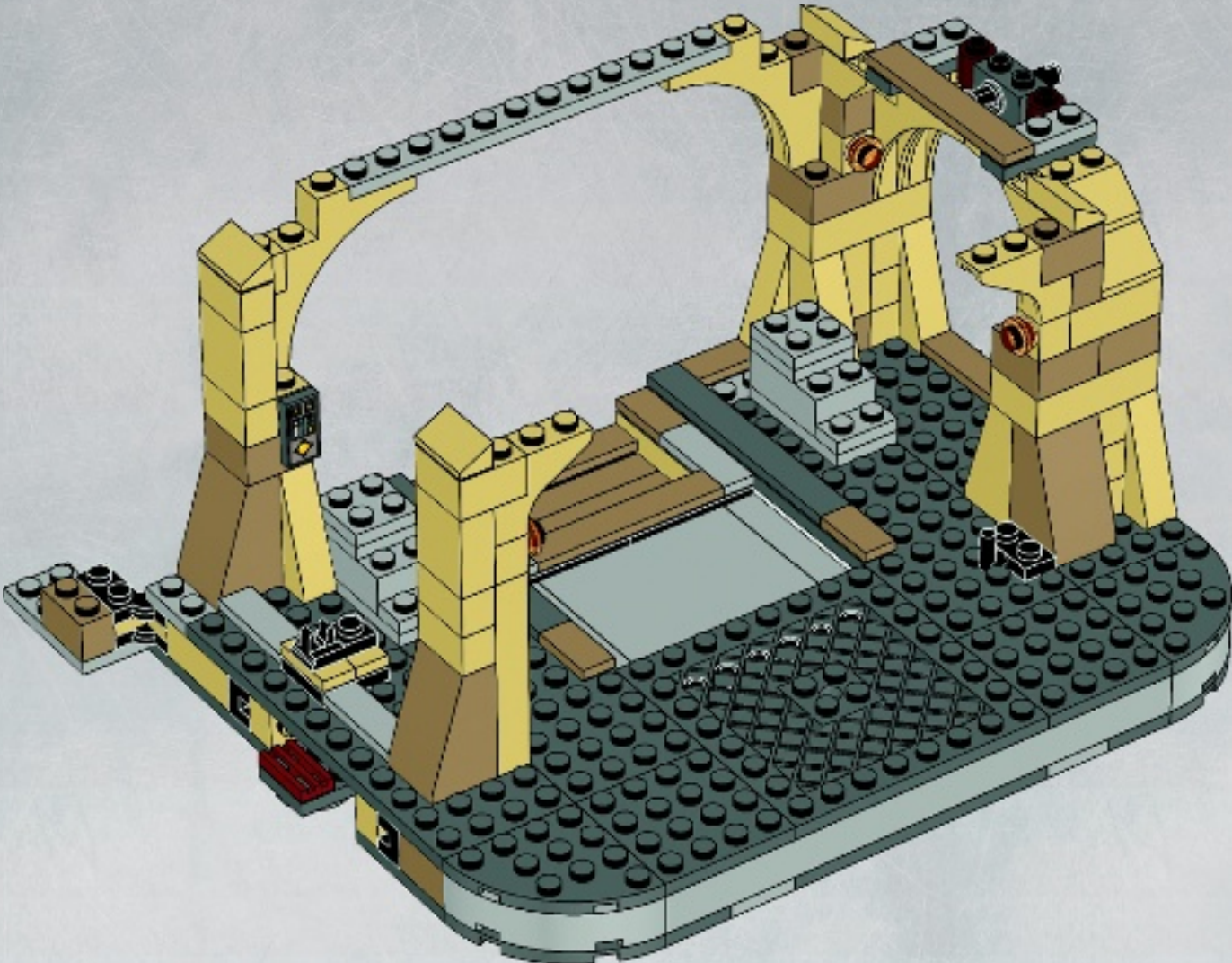

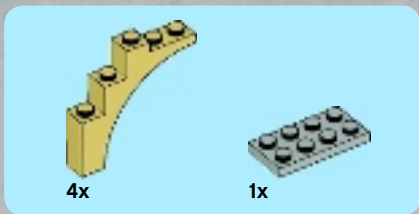

38

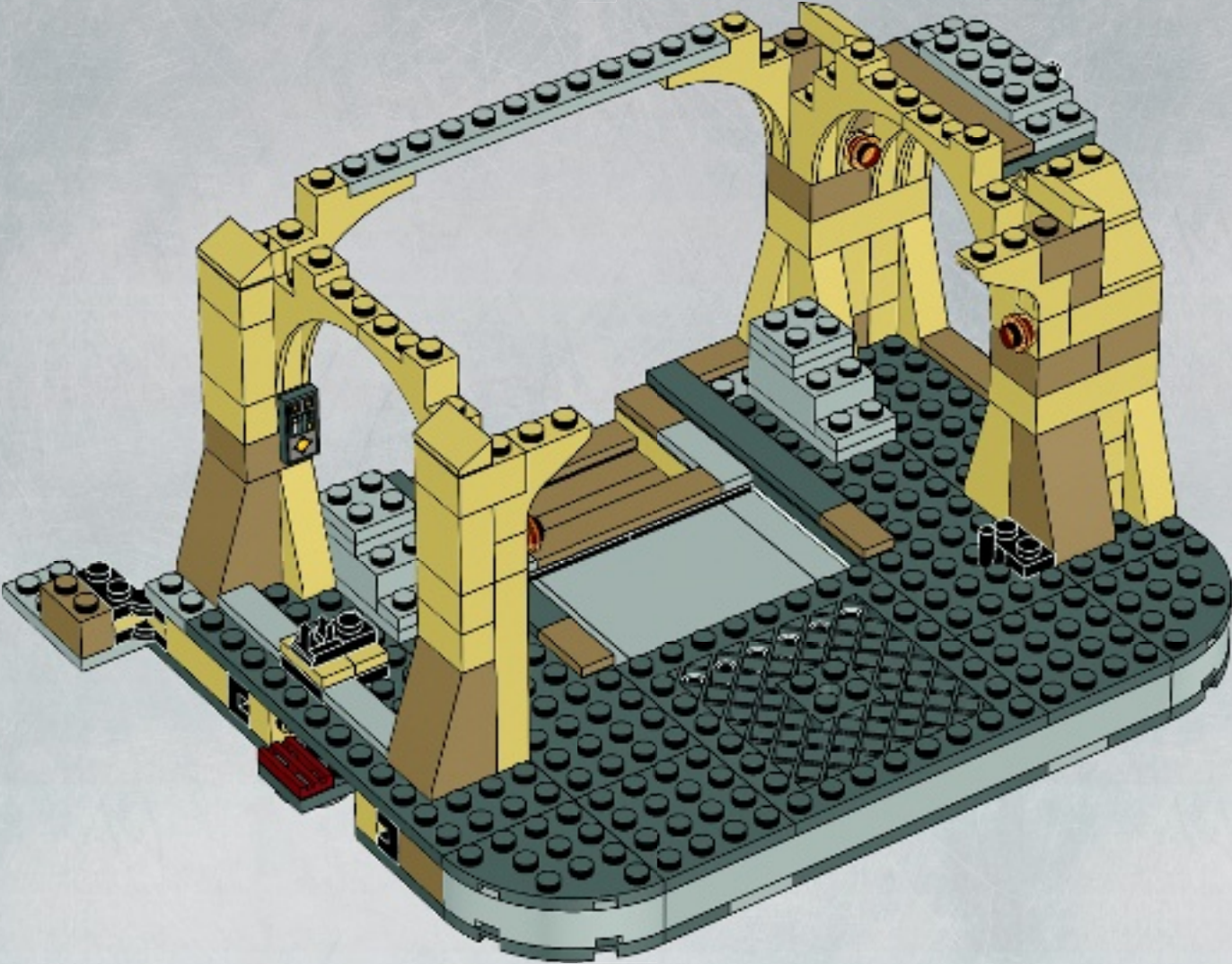





2x

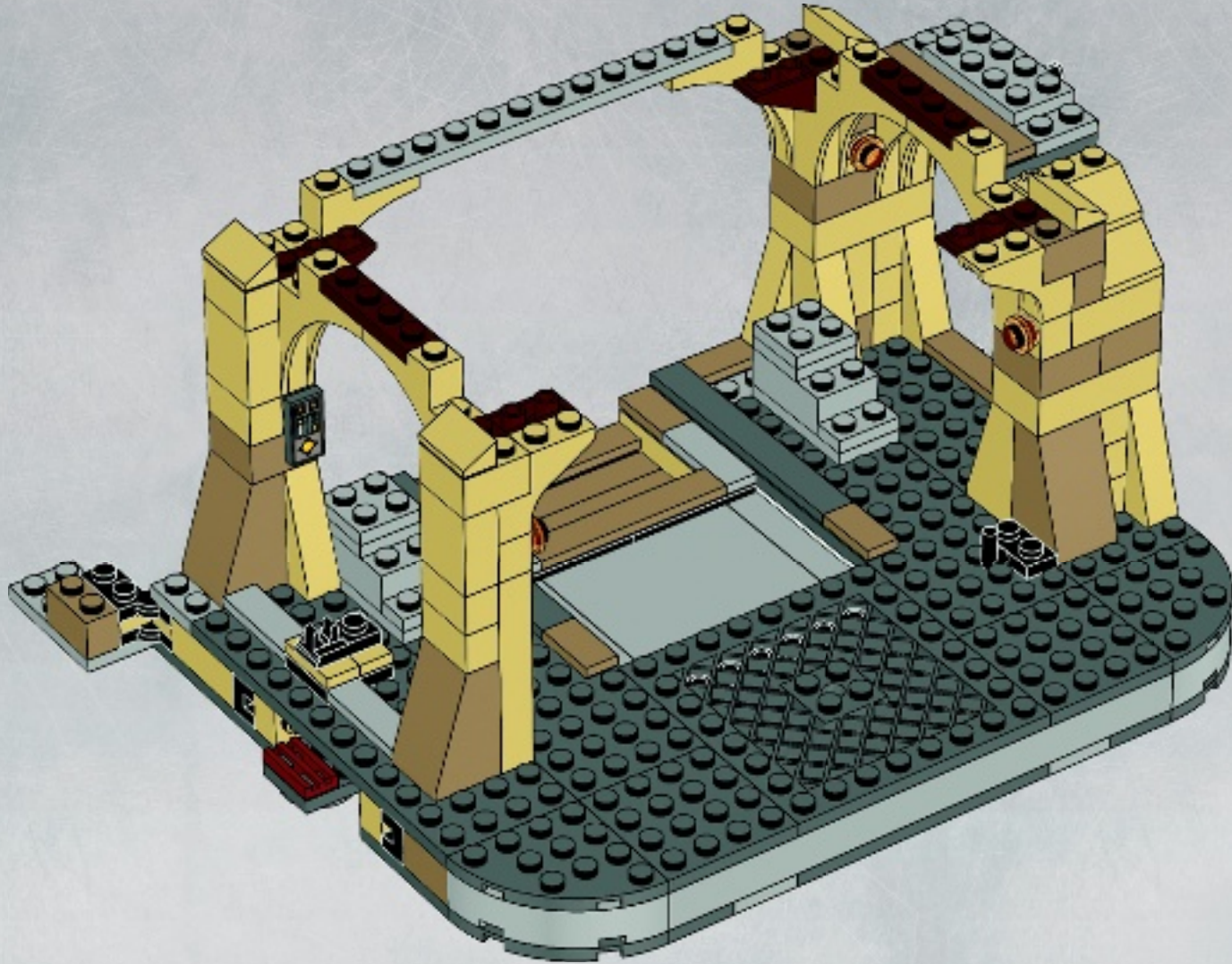

4x

39



4x  6x 

40

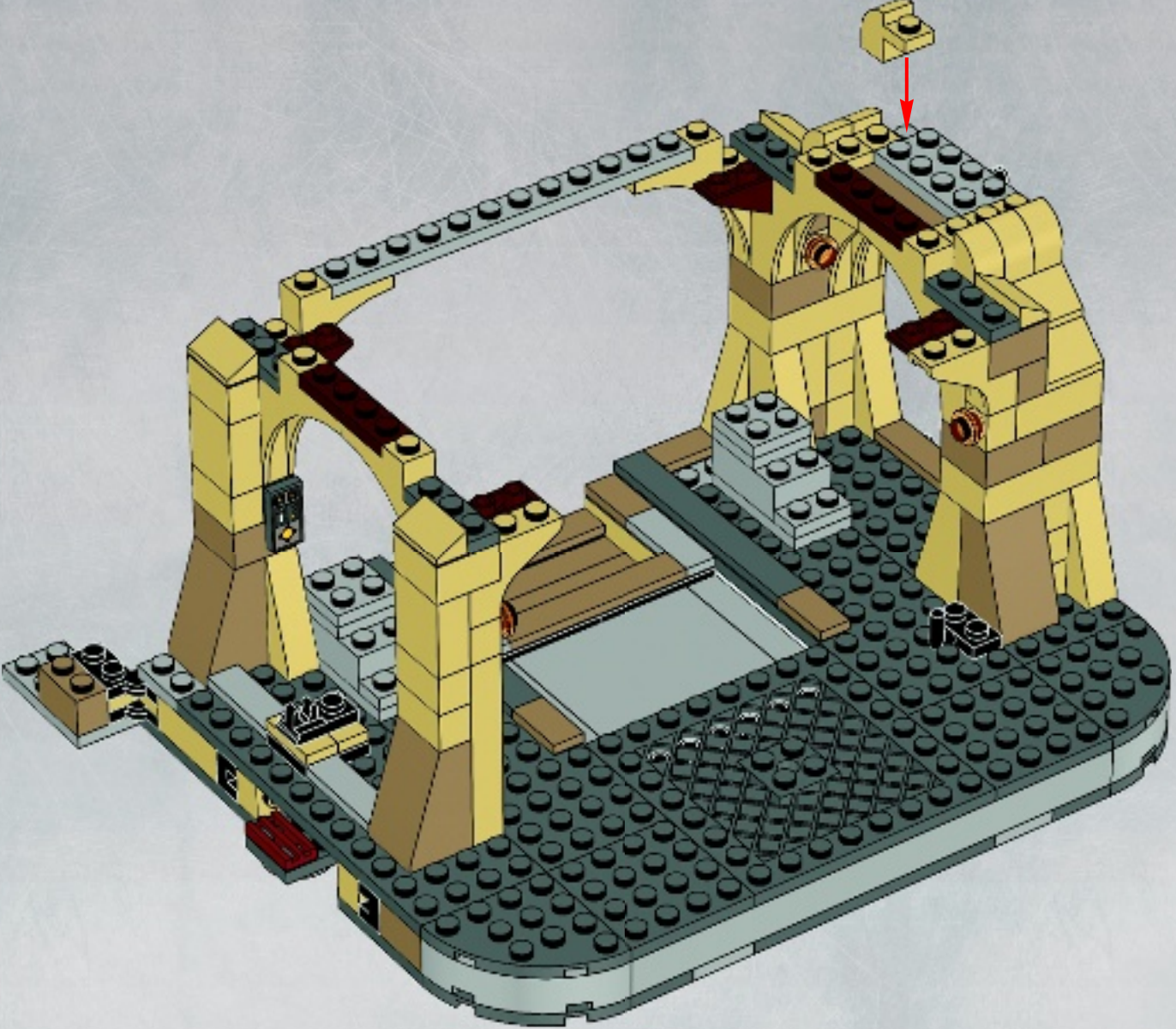



1x



2x

41

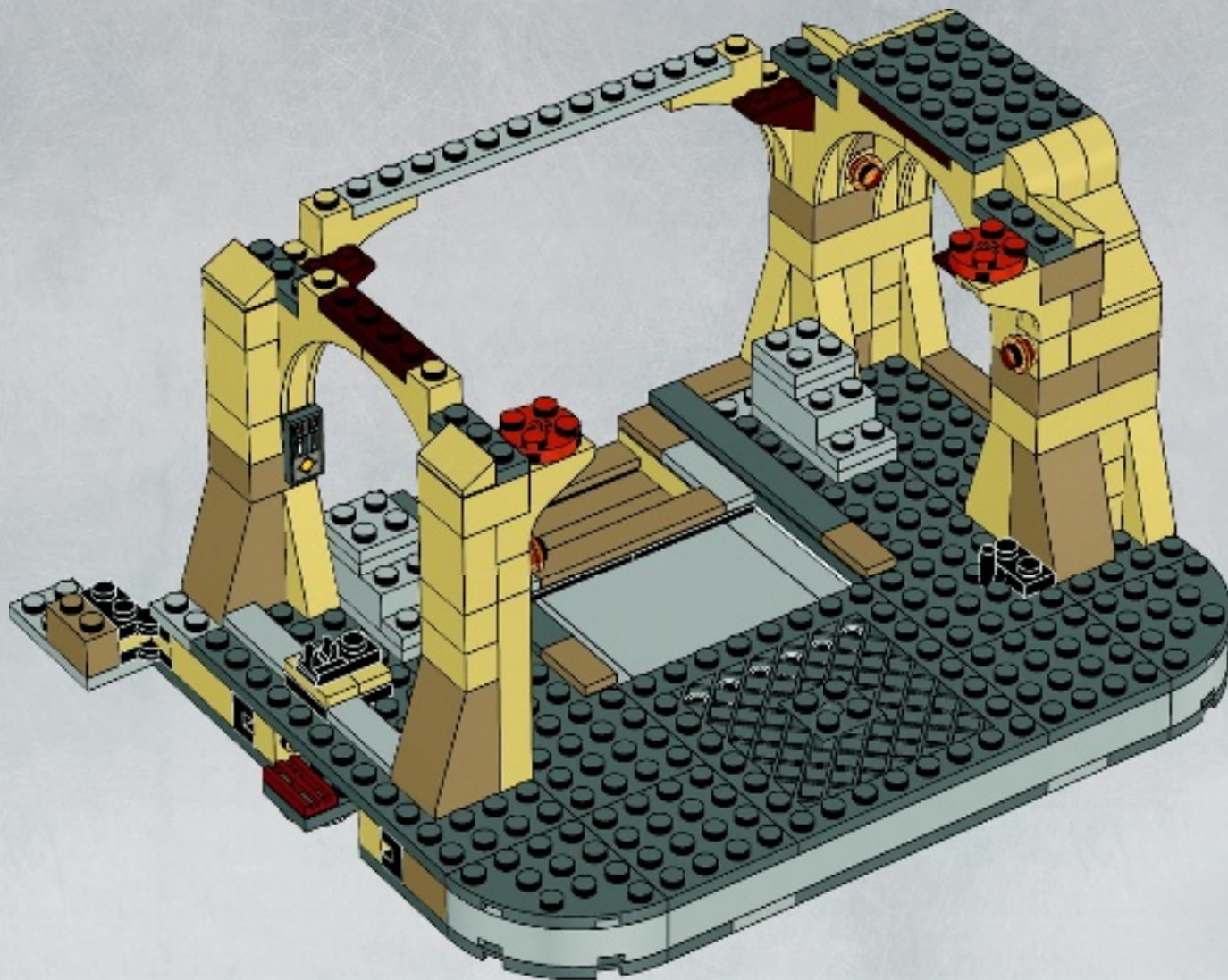



2x



2x



2x

42

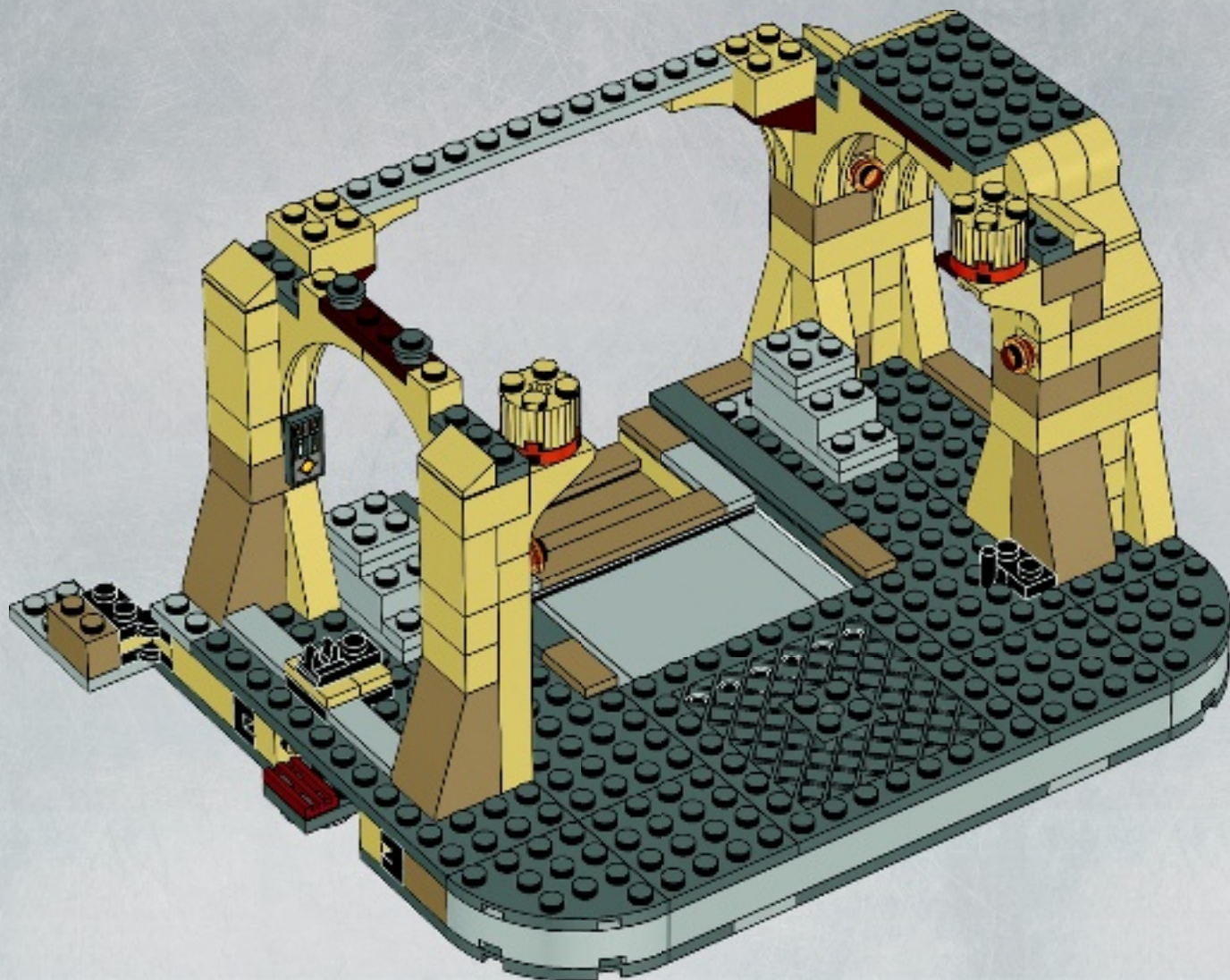



8x



2x



2x

43

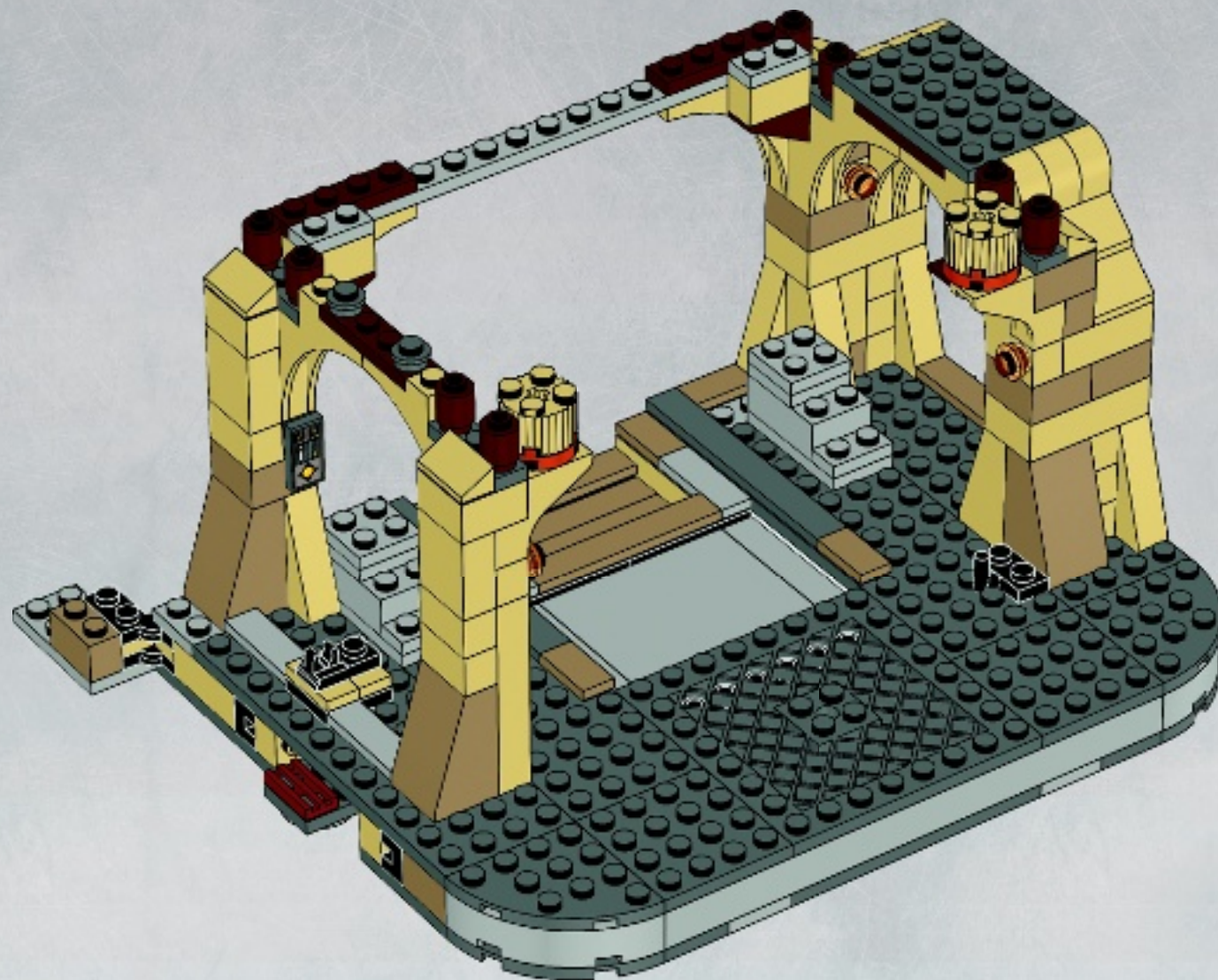

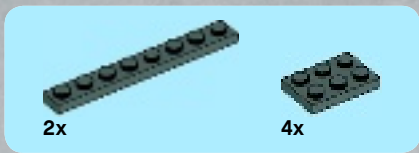

44

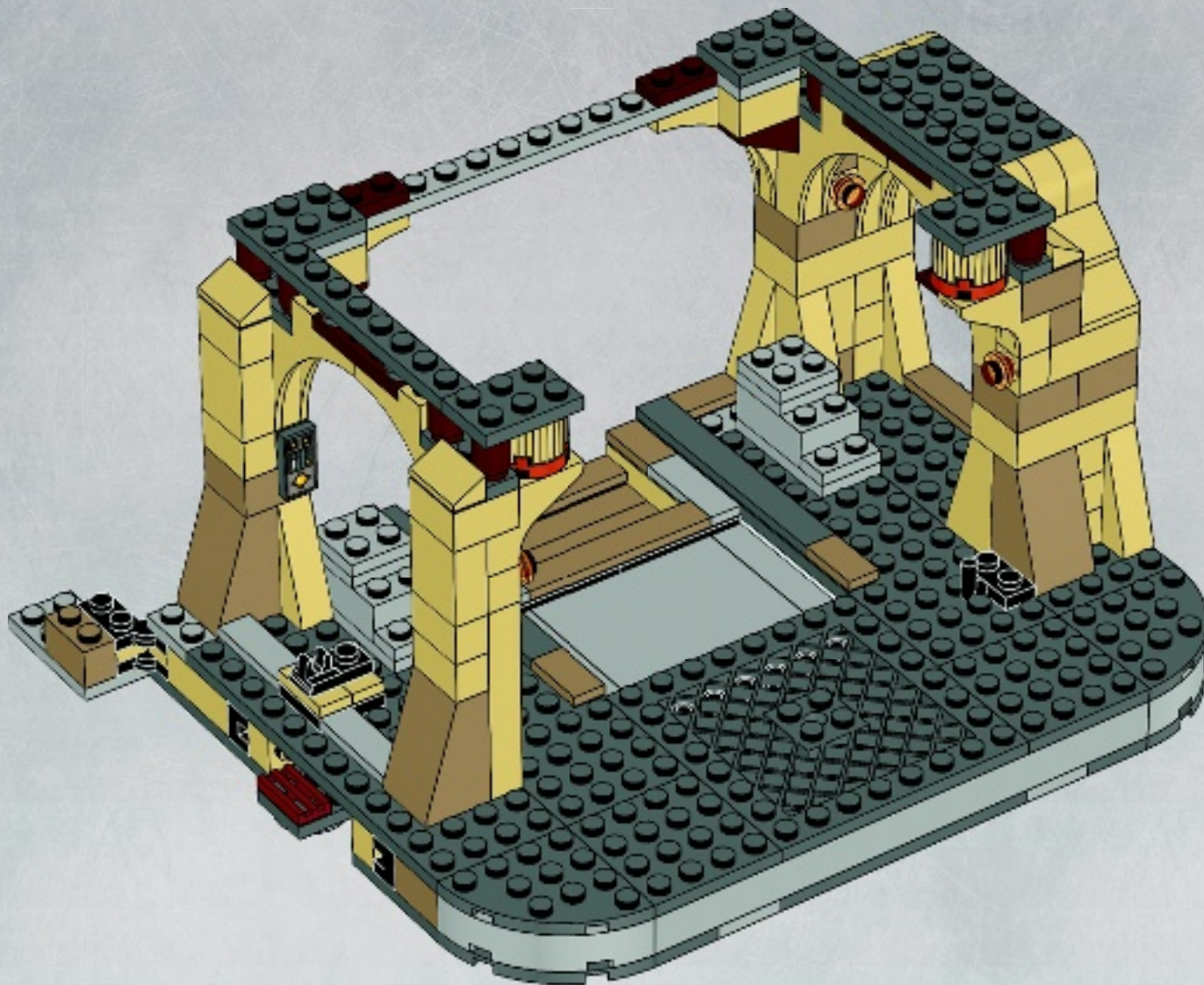



4x



4x

45

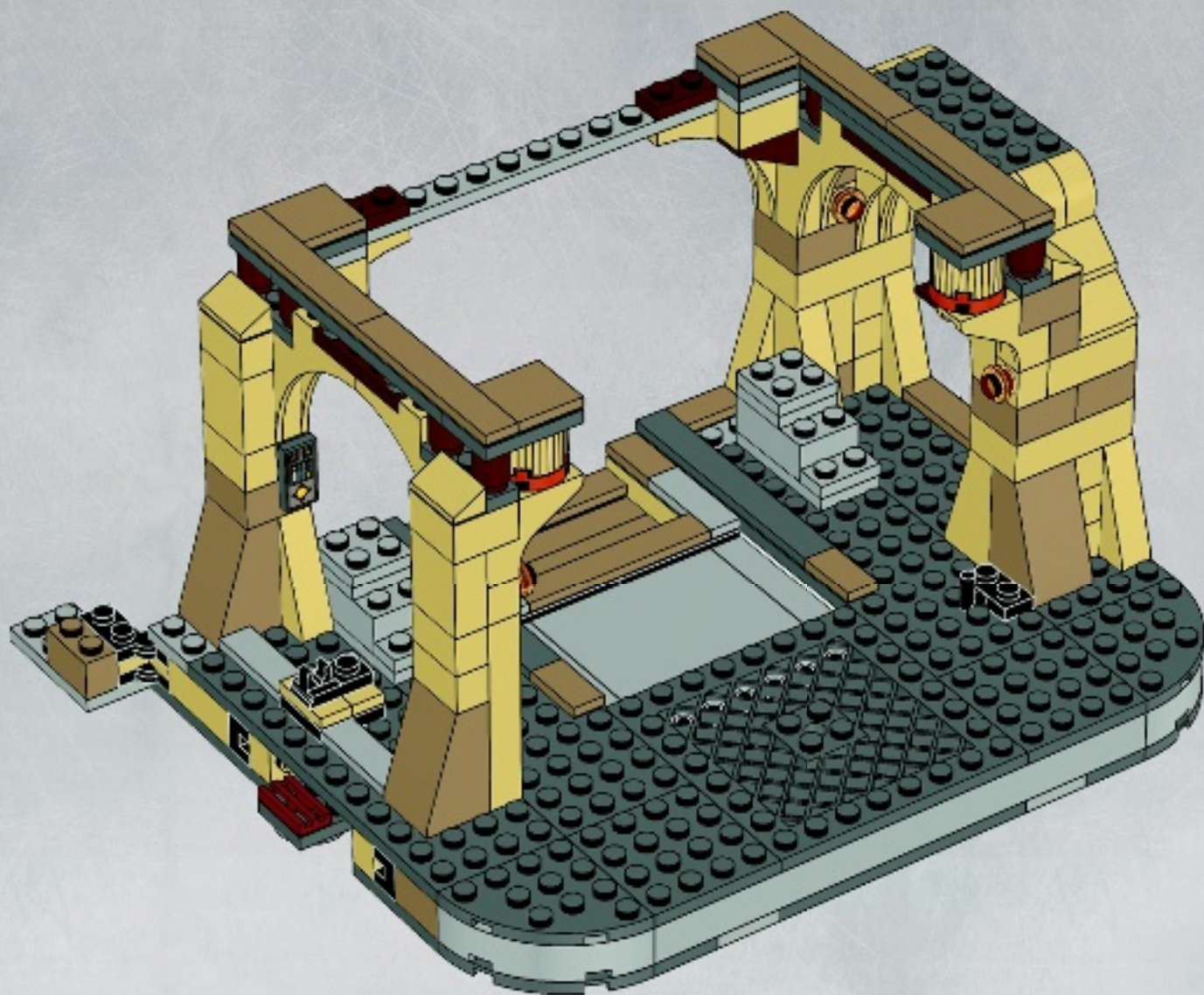



1

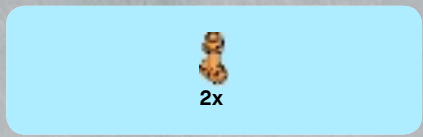

3

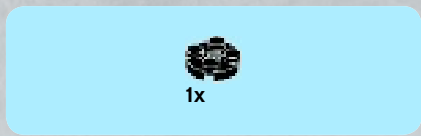

2

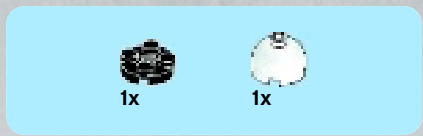

4

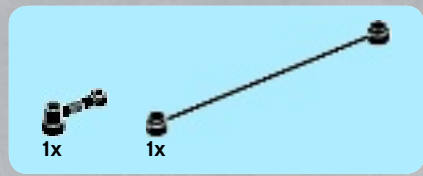

5

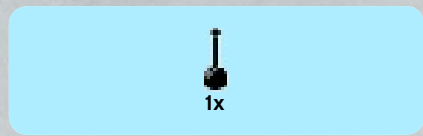

6



46

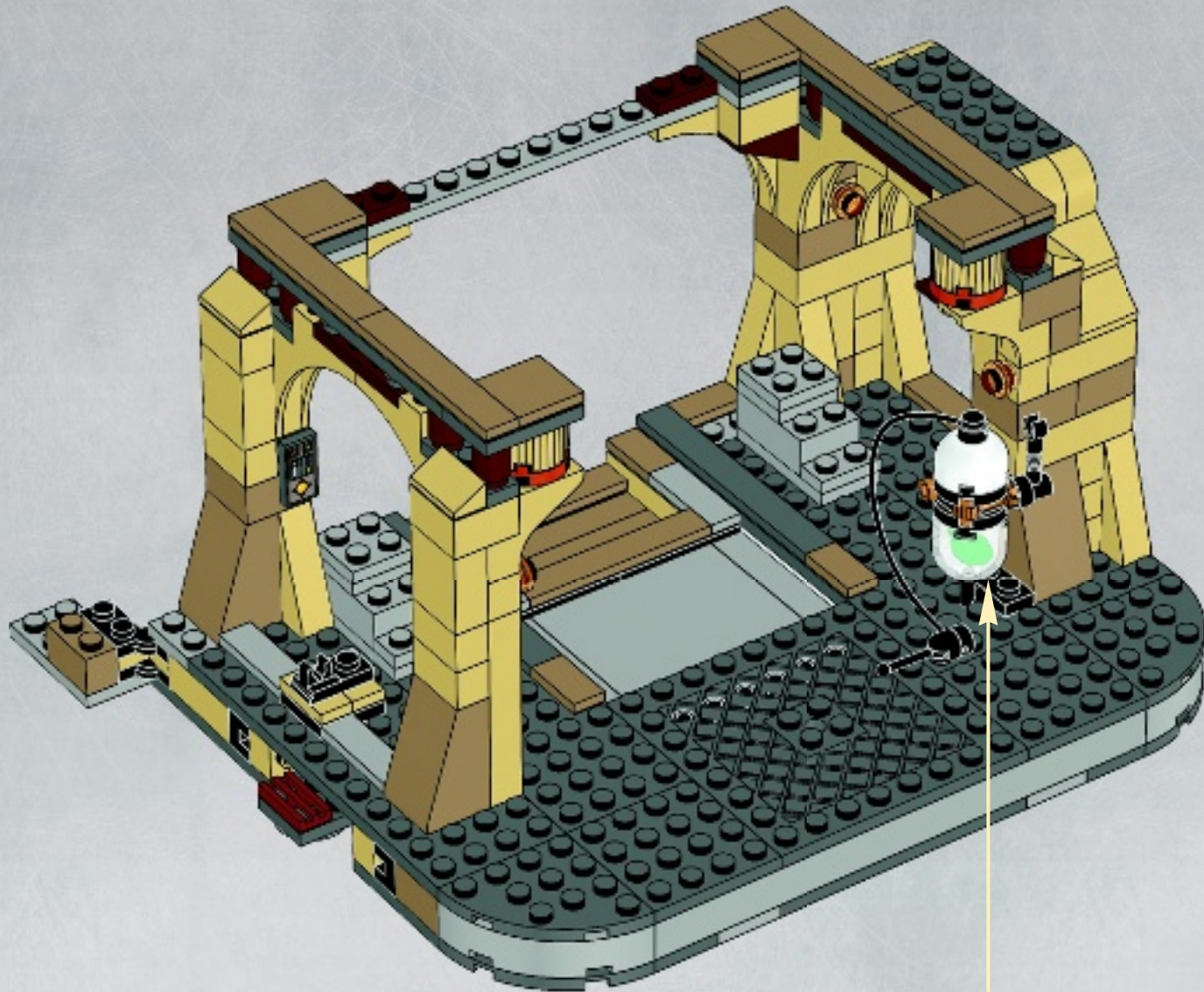

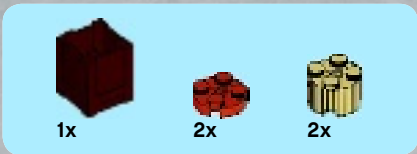

47

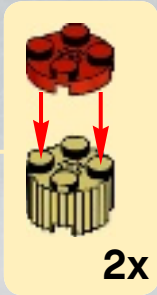
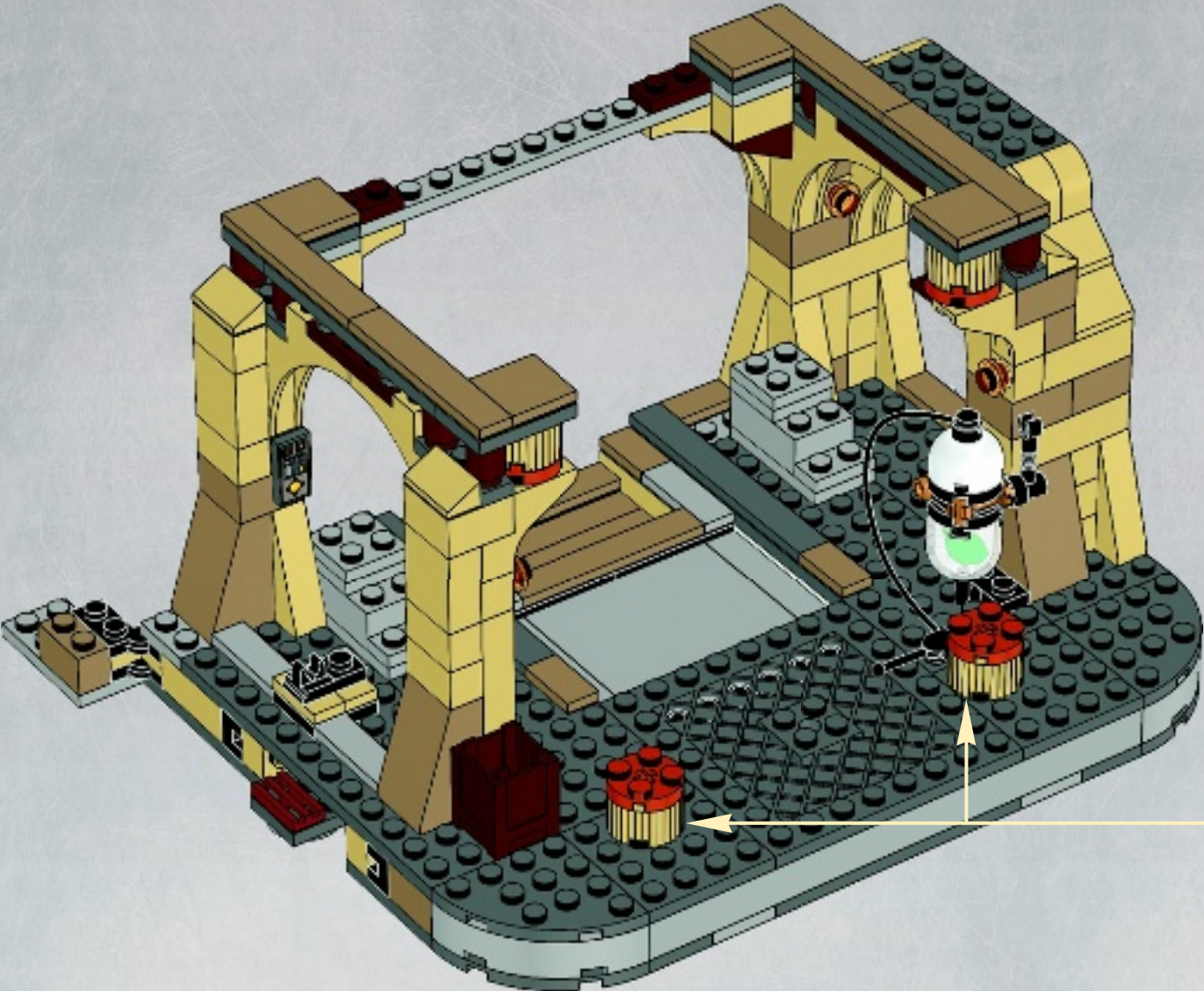

1x

1x

1x

2x

2x

48

